

Nomadic  **Display**®

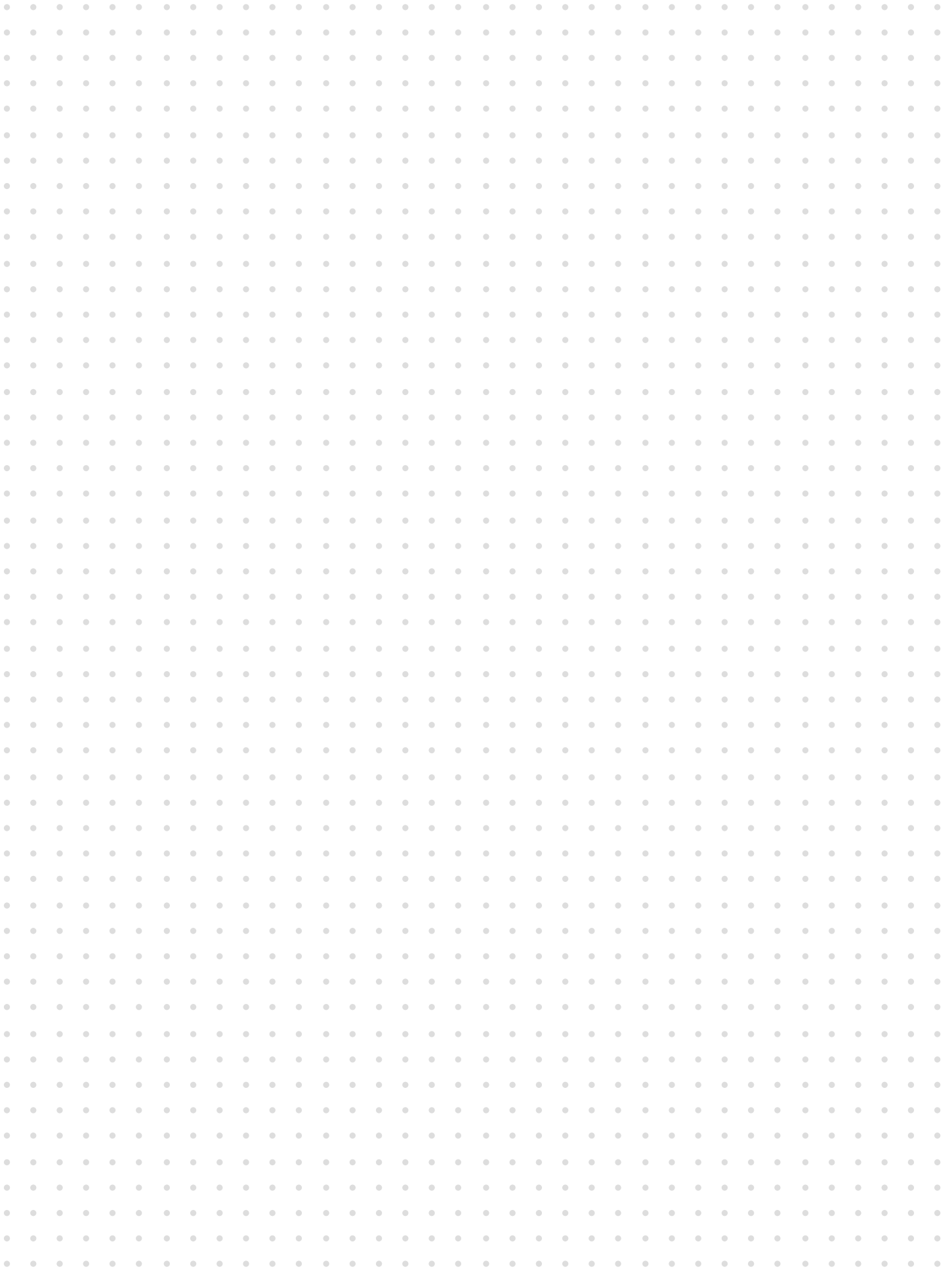

EDGE
PRODUCT CATALOGUE

NOTES





WHY CHOOSE **NOMADIC DISPLAY** AS YOUR EXHIBITION PARTNER ?

With a rich history and unmatched expertise, Nomadic Display remains the go-to choice for businesses worldwide.



PIONEERING LEGACY

Nomadic Display pioneered the exhibition industry over 40 years ago with Ted Zeigler's invention of the "Pop Up Stand." When you partner with us, you're tapping into decades of groundbreaking design and unparalleled expertise.



UNMATCHED PRODUCT DIVERSITY

From Modular Stands to LED Backlit Displays, we offer a diverse range of products tailored to every need. Our dedication to innovation ensures that we consistently go beyond client expectations.



COMMITMENT TO CLIENT SUCCESS

At Nomadic Display, we don't just focus on transactions; we emphasize building genuine partnerships with our clients. By ensuring mutual success, we take pride in our dedicated team that offers exceptional post-purchase support to every customer.



40+

Years of Experience in the Exhibition Industry



100+

Award Winning Projects



20,000+

Satisfied Clients

OUR CORE VALUES



Partnerships



Sustainability



Quality



Professionalism



Innovation



Integrity

At the core of everything we do lies professionalism, integrity, innovation, and sustainability. Our mission is to forge lasting strategic partnerships with our customers. We are committed to setting the benchmark in the exhibition and display industries, delivering high-quality products with a guarantee of 100% satisfaction.

ABOUT US

 Made in Europe

Our team at Nomadic Display has been working for over 40 years to help you get the most out of your time spent at trade shows, exhibitions, and other sales events. The exhibition stands we create are some of the most innovative and economical in the industry, and they provide real returns for our clients, both now and in the future.

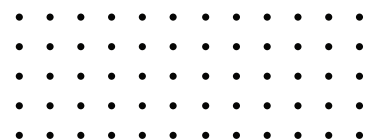

GREEN COMMITMENT

A DEVOTION TO ENVIRONMENTAL LEADERSHIP IN THE EXHIBITION INDUSTRY

Since our inception, Nomadic Display has championed sustainability. We're an eco-conscious company, always innovating to optimize our energy and resource use. Our commitment runs deep, evidenced by our efforts to curtail our carbon footprint, reduce waste, and conserve water.



SEAMLESS ADAPTABILITY

Our products are masterfully designed to cater to multiple events, not only minimizing waste but also maximizing your investment. Each product's versatility ensures adaptability across your exhibition calendar.

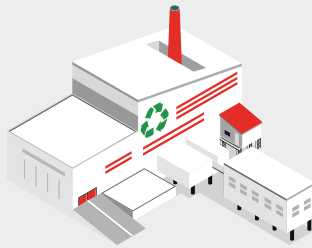

EARTH-CONSCIOUS CRAFTING

At the foundation of our production is high-quality, recycled materials. Our eco-friendly manufacturing goes beyond mere processes; it's our commitment to the planet. Even in the rare instances of wastage, we prioritize recycling and repurposing.



TIMELESS DURABILITY

We don't just create products; we build legacies. Our items are designed for longevity and to withstand repeated use. Every piece we create is backed by our unwavering warranties, a testament to our faith in their durability.

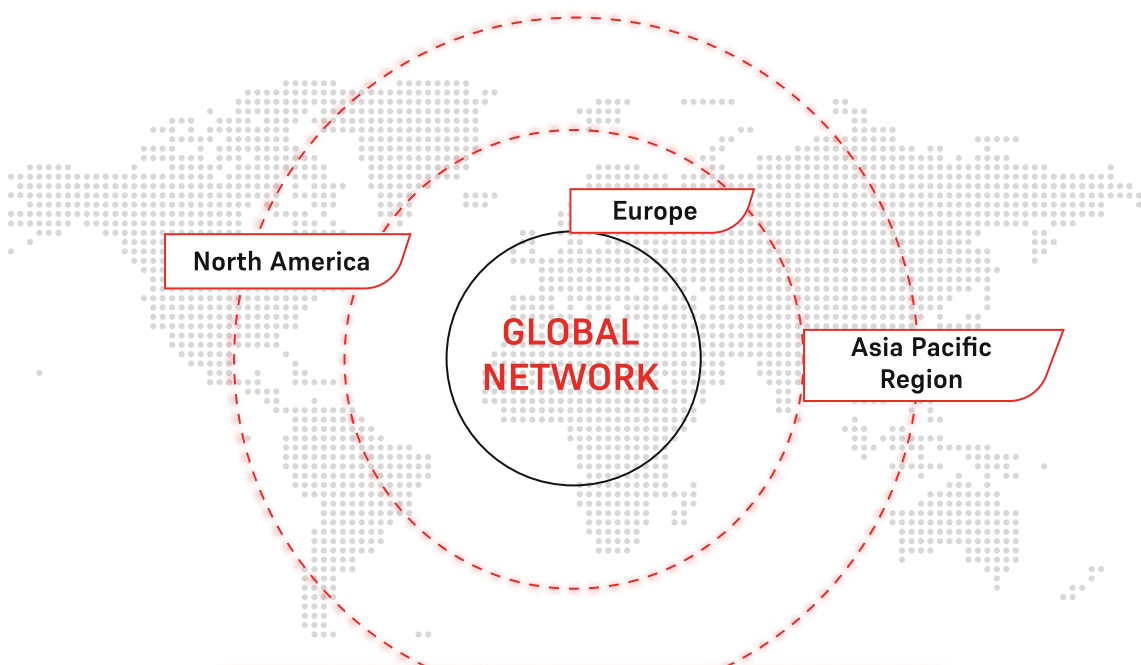

We are available all around the world through our extensive distribution network

EXHIBITION SERVICES

YOUR ONE-STOP SOLUTION FOR SEAMLESS EXHIBITIONS

At Nomadic Display, we understand the intricacies of the exhibition world. That's why we offer a comprehensive range of services designed to make your exhibition journey smooth and hassle-free.

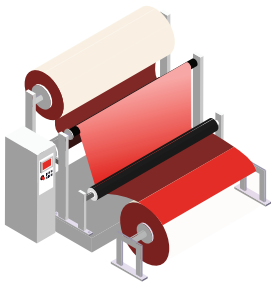

IN-HOUSE PRINTING

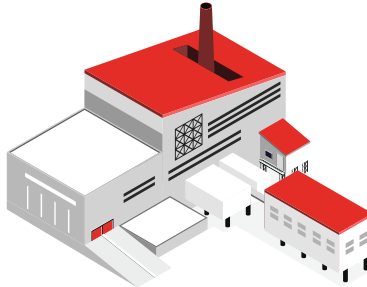

EXHIBITION STAND MANUFACTURING



GLOBAL EXHIBITION STAND INSTALLATION



EXHIBITION STAND RENTAL

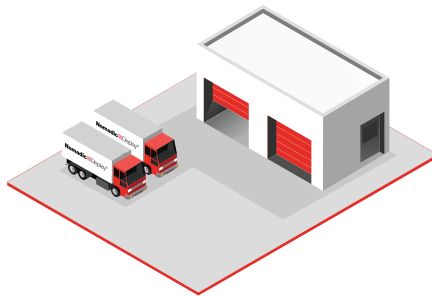

EXHIBITION STORAGE



24/7 SUPPORT



EXHIBITION STAND DESIGN

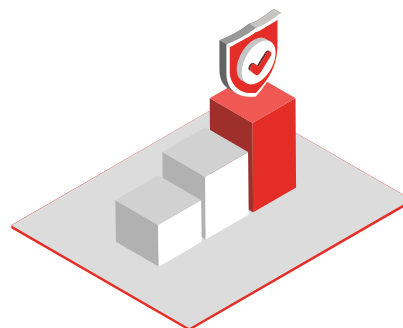

INDUSTRY LEADING WARRANTIES

At Nomadic Display, we pride ourselves on offering a comprehensive suite of exhibition solutions tailored to meet the diverse needs of businesses worldwide. Our commitment to innovation, quality, and versatility shines through in every product we craft.

OUR PREMIER PRODUCT CATEGORIES



MODULAR EXHIBITION STANDS

Crafted for flexibility and impact, our modular stands can be tailored to fit any exhibition space, ensuring your brand remains the focal point.

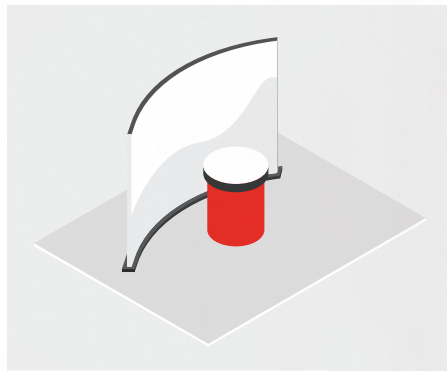

POP-UP STANDS

As the pioneers of the Pop Up Stand, we offer lightweight and portable options that are perfect for exhibitors on the go, ensuring a grand impression in any setting.

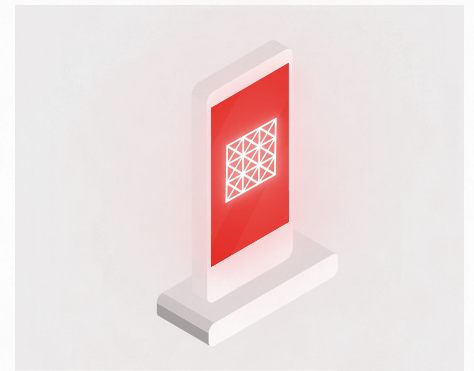

LED BACKLIT DISPLAYS

Illuminate your brand message with our state-of-the-art LED backlit displays. Designed to captivate and engage, these displays are a beacon of innovation.

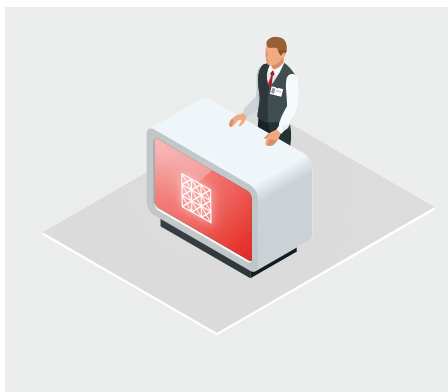

LED BACKLIT COUNTERS

Combine functionality with aesthetics. Our LED backlit counters not only serve as an interactive space but also enhance the ambiance of your exhibition area.

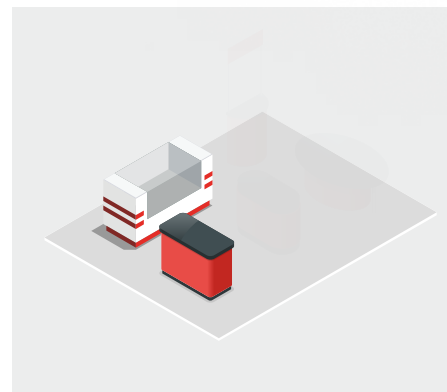

EXHIBITION COUNTERS

From product showcases to interactive hubs, our range of exhibition counters are designed to be both practical and visually appealing.



EXHIBITION ACCESSORIES

Complete your exhibition setup with our curated range of accessories. From lighting solutions to graphic panels, we've got everything you need to enhance your display.

OUR CLIENTELE

Over the years, we have established ourselves as a trusted name in the exhibition industry. Our journey began with a simple vision: to provide unparalleled products and services that would help businesses showcase their brands in the best light possible. Today, we are proud to say that we have turned that vision into a reality.

JOIN **20,000+** SATISFIED CLIENTS
GLOBALLY IN TRUSTING **NOMADIC
DISPLAY**

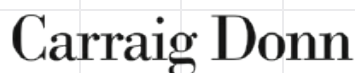

OUR EXHIBITION SOLUTIONS ARE CERTIFIED FOR EXCELLENCE

At Nomadic Display, our exhibition solutions are certified under three categories, upholding industry standards for quality, safety, and performance. Rest assured, our products are crafted to provide you with the best possible display experience.





THE SYSTEM DESIGNED FOR YOU!

EDGE is a system that is made up of the essential elements required for your exhibition display. We have pre-packaged all of our modules (display walls, towers, storage & arches) in a range of the most popular sizes to give you the best solution for your clients individual needs.

EDGE gives you the ability to confidently quote simple designs quickly and efficiently. Why not take this to the next level by receiving a **free** 3D colour rendering from our Solutions Design department in as little as 2 days!

Combine EDGE modules together to create an endless amount of unique designs and integrate with all other Nomadic Display product ranges.

BUILD



EASY AS 1,2,3!

EDGE walls are simple to set-up with our user friendly connection methods and pre-assembled corners.

EDGE pre-assembled corners ensure a 90 degree corner every time and results in a streamlined, stress-free set-up.

Complete your display wall using our dye sub SEG printed fabric graphics to achieve a crease-free, high impact image!

GROW

EDGE represents everything that Nomadic Display stands for - *durability, versatility and value for money.*

All our EDGE modules are designed so the focus is on your evolving and ever changing exhibition needs, every EDGE solution you purchase today can grow over time with your changing exhibition needs.

Each module expands in width and height to ensure that your purchase will work in all environments time after time.

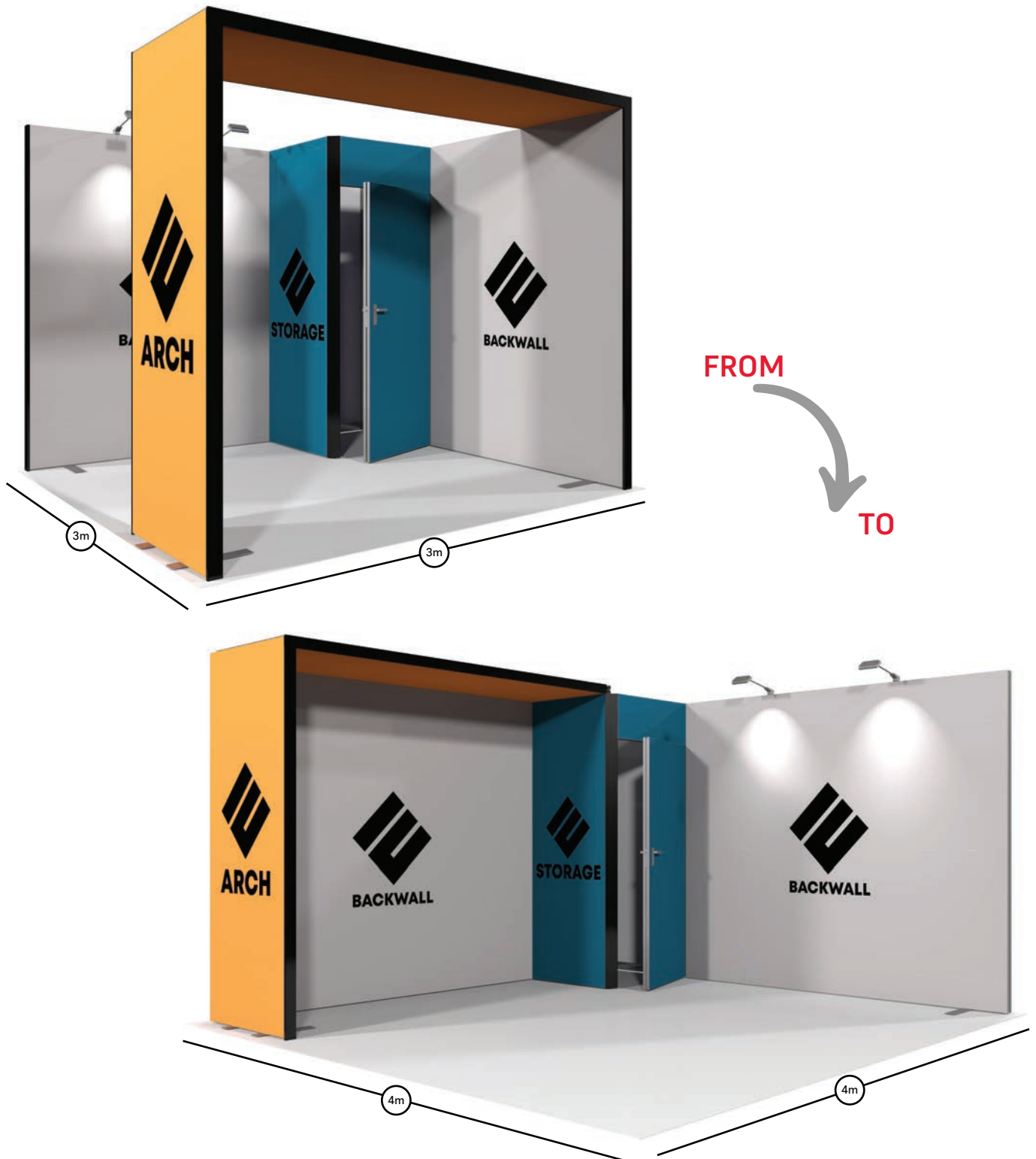

GROW

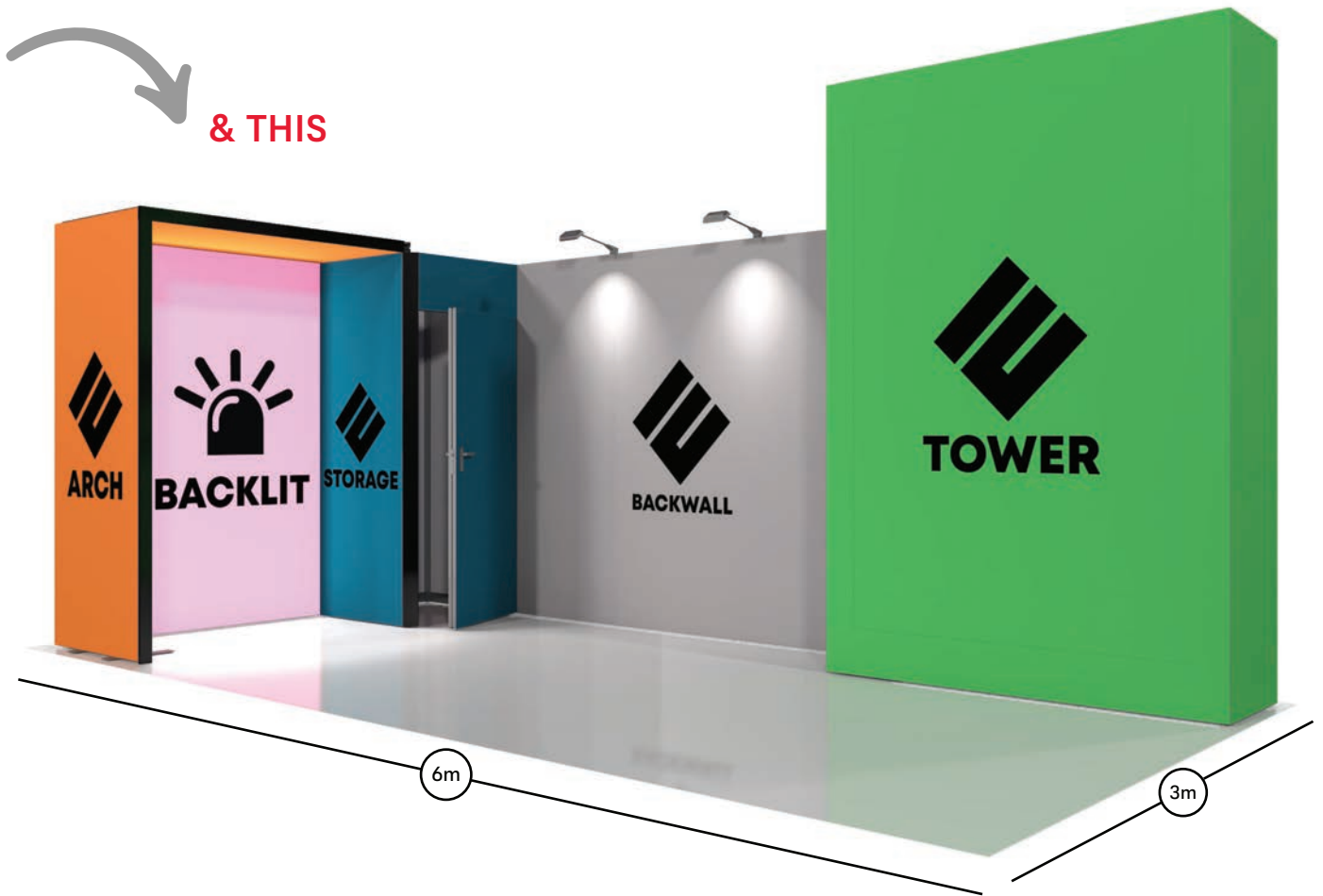

CONTACT OUR DESIGN TEAM

Use our **free solutions design service** to unlock the full potential of your exhibition space.

No-one knows the EDGE system like our designers! With years of experience designing unique environments, we can help you create an exhibition that not only excites you today but grows with you over years to come.

ACCESSORIES

Accessorise your EDGE modules with our range of great add-ons.
Contact our solutions team to enquire about how our accessories can integrate with your display.

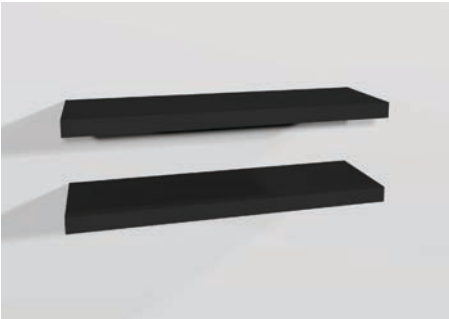

Floating Product Display Shelf



iPad Display



A4 Literature Holder



Monitor Mount - up to 60"



LED Lights



Endcaps

BASEPLATES

All our EDGE display walls include flat baseplates as standard, however if you have a specific need and want to change baseplates you can at no additional charge. Simply state your preferred baseplate when ordering and we will send you your preferred baseplate.

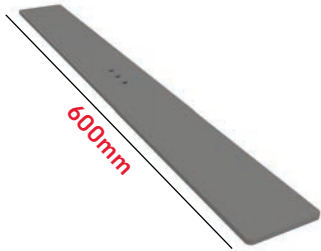

Flat Center Baseplates

Used for stand alone walls, these baseplates provide a sleek look and excellent stability.



Side Mounted Half Moon Baseplates

Attached to the side of your stand alone display, these baseplates provide ultimate stability.

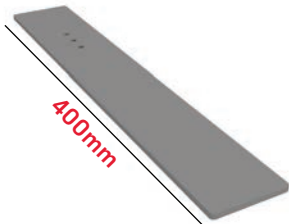

Flat Offset Baseplates

These baseplates are used with our corner display walls to maximise the floor space.

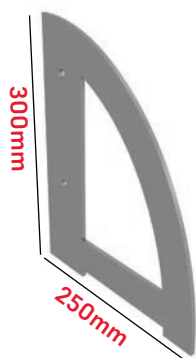

Quarter Round Side Mounted Baseplates

These space saving baseplates attach to the side of your display providing great stability.

TRANSPORT CASES

All our EDGE modules are securely packed in our range of transport cases, however if you wish to change the packing for any reason you can specify your preferred packing option below.



FlatPack 300

Pack multiple units in one case to reduce costs and make shipping easier.

External Case Dimensions

W 720mm x H 350mm x D 1300mm



FlatPack 200

Pack multiple units in one case to reduce costs and make shipping easier.

External Case Dimensions

W 720mm x H 280mm x D 1300mm



Extra Large Poly Case

Poly cases are a great lightweight yet durable packing solution for your display.

External Case Dimensions

W 670mm x H 230mm x D 1360mm



Large Poly Case

Poly cases are a great lightweight yet durable packing solution for your display.

External Case Dimensions

W 600mm x H 230mm x D 1360mm



Small Poly Case

Poly cases are a great lightweight yet durable packing solution for your display.

External Case Dimensions

W 440mm x H 230mm x D 1360mm

BACKWALL

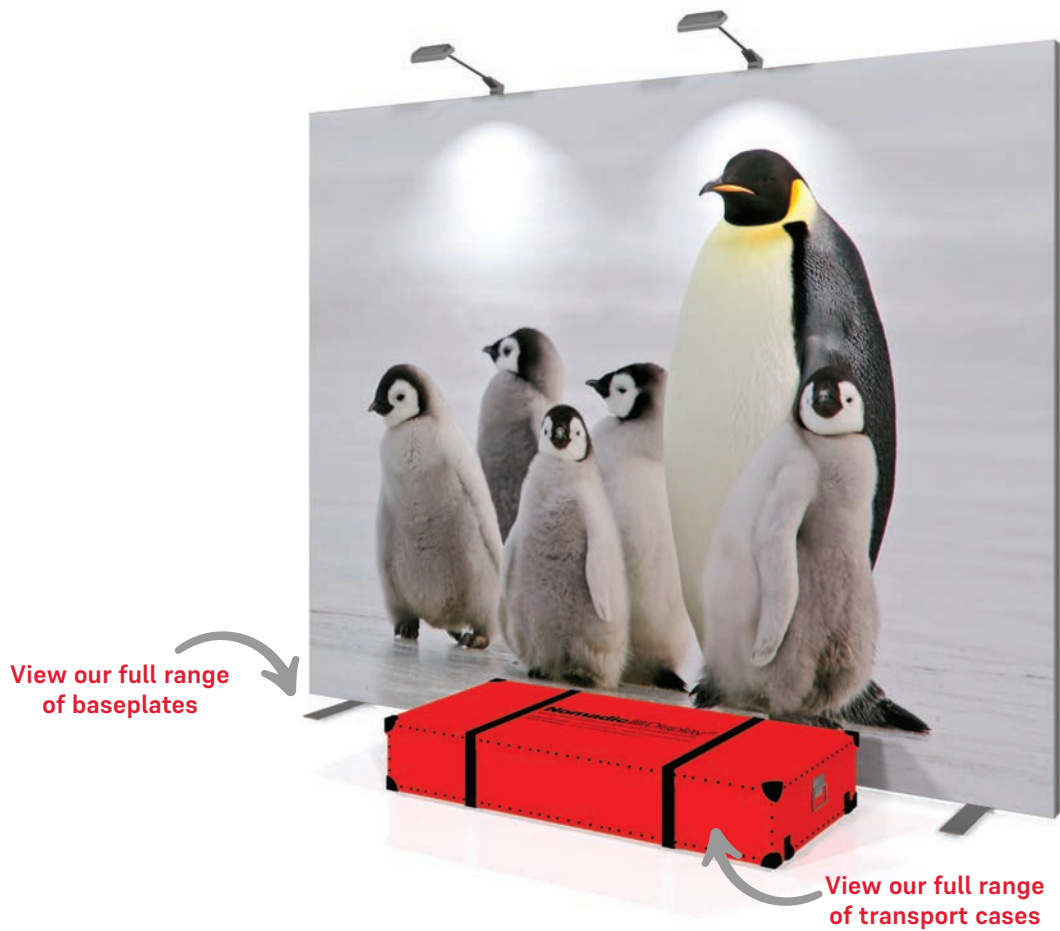

EDGE portable backwalls are the perfect way to get your companies message out there. Our pre-packaged walls provide you with a unique, portable and modular exhibit. All our walls come complete with 2 x flat steel baseplates and are packed in a wheeled transport case.



ACCESSORISE

Enhance your display by adding LED down lights, or choose from our wide range of accessories (including TV mounts, product display shelves and much more)

COMPLETE

Complete your display by covering any exposed aluminium with our specially designed endcaps. Choose from white, black or silver to give you a flawless/ channel free finish



MODULAR

Remove/add meter sections to reconfigure your display

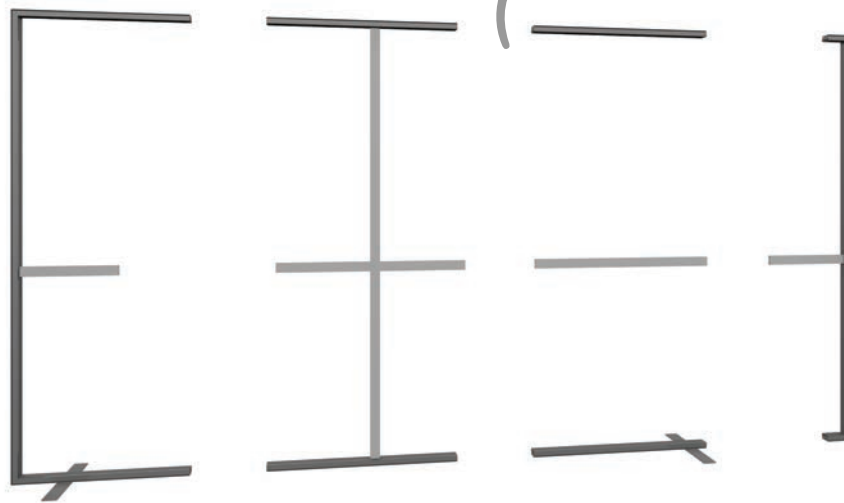

FROM TO

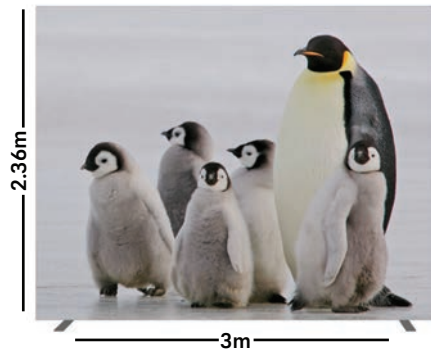

& THIS



COMBINE

All our displays work best together. Combine multiple units together to create a show stopping display!



BACKWALL CODES (2.36M HIGH)

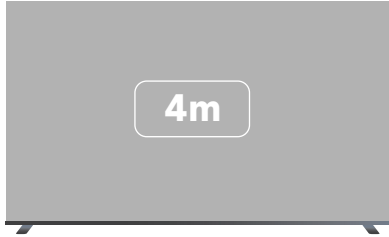

W 4m x H 2.36m

	PRODUCT CODE	DESCRIPTION
Hardware Printed Fabric	WSEW40236K	4 x 2.36m EDGE backwall kit in a fabricated case
	WSEWFAB40236	4 x 2.36m EDGE backwall printed fabric graphics

Product when assembled : W 4000mm x H 2360mm x D 600mm

Transport Case : Extra Large Poly Case - 48 kg

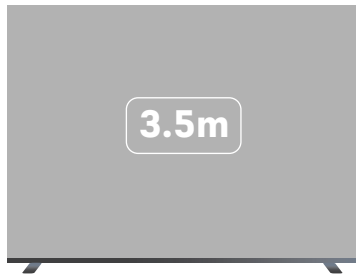

W 3.5m x H 2.36m

	PRODUCT CODE	DESCRIPTION
Hardware Printed Fabric	WSEW35236K	3.5 x 2.36m EDGE backwall kit in a fabricated case
	WSEWFAB35236	3.5 x 2.36m EDGE backwall printed fabric graphics

Product when assembled : W 3500mm x H 2360mm x D 600mm

Transport Case : Extra Large Poly Case - 46 kg

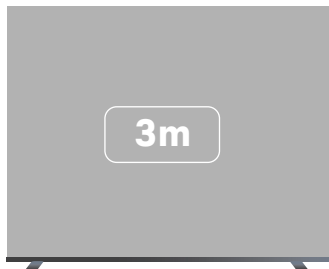

W 3m x H 2.36m

	PRODUCT CODE	DESCRIPTION
Hardware Printed Fabric	WSEW30236K	3 x 2.36m EDGE backwall kit in a fabricated case
	WSEWFAB30236	3 x 2.36m EDGE backwall printed fabric graphics

Product when assembled : W 3000mm x H 2360mm x D 600mm

Transport Case : Large Poly Case - 40 kg

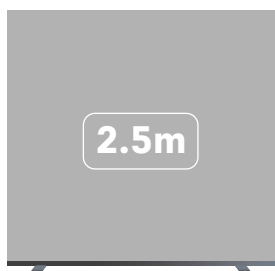

W 2.5m x H 2.36m

	PRODUCT CODE	DESCRIPTION
Hardware Printed Fabric	WSEW25236K	2.5 x 2.36m EDGE backwall kit in a fabricated case
	WSEWFAB25236	2.5 x 2.36m EDGE backwall printed fabric graphics

Product when assembled : W 2500mm x H 2360mm x D 600mm

Transport Case : Extra Large Poly Case - 38 kg

*Custom sizes are available on request.

BACKWALL CODES (2.36M HIGH)

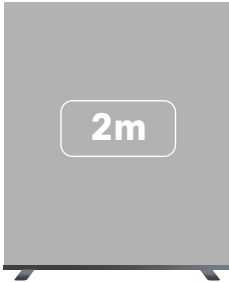

W 2m x H 2.36m

	PRODUCT CODE	DESCRIPTION
Hardware Printed Fabric	WSEW20236K	2 x 2.36m EDGE backwall kit in a fabricated case
	WSEWFAB20236	2 x 2.36m EDGE backwall printed fabric graphics

Product when assembled : W 2000mm x H 2360mm x D 600mm

Transport Case : Extra Large Poly Case - 35 kg

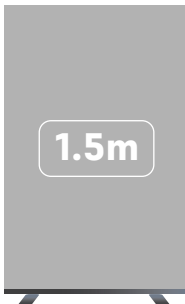

W 1.5m x H 2.36m

	PRODUCT CODE	DESCRIPTION
Hardware Printed Fabric	WSEW15236K	1.5 x 2.36m EDGE backwall kit in a fabricated case
	WSEWFAB15236	1.5 x 2.36m EDGE backwall printed fabric graphics

Product when assembled : W 1500mm x H 2360mm x D 600mm

Transport Case : Small Poly Case - 32 kg



W 1m x H 2.36m

	PRODUCT CODE	DESCRIPTION
Hardware Printed Fabric	WSEW10236K	1 x 2.36m EDGE backwall kit in a fabricated case
	WSEWFAB10236	1 x 2.36m EDGE backwall printed fabric graphics

Product when assembled : W 1000mm x H 2360mm x D 600mm

Transport Case : Small Poly Case - 27 kg

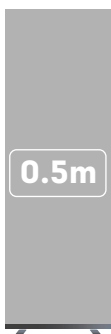

W 0.5m x H 2.36m

	PRODUCT CODE	DESCRIPTION
Hardware Printed Fabric	WSEW05236K	0.5 x 2.36m EDGE backwall kit in a fabricated case
	WSEWFAB05236	0.5 x 2.36m EDGE backwall printed fabric graphics

Product when assembled : W 500mm x H 2360mm x D 600mm

Transport Case : Small Poly Case - 25 kg

BACKWALL CODES (2.5M HIGH)

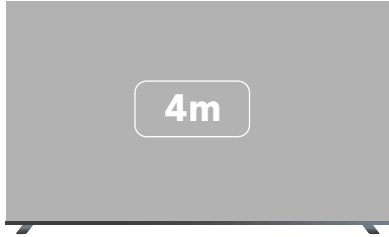

W 4m x H 2.5m

	PRODUCT CODE	DESCRIPTION
Hardware Printed Fabric	WSEW40250K	4 x 2.5m EDGE backwall kit in a fabricated case
	WSEWFAB40250	4 x 2.5m EDGE backwall printed fabric graphics

Product when assembled : W 4000mm x H 2500mm x D 600mm

Transport Case : Extra Large Poly Case - 48 kg

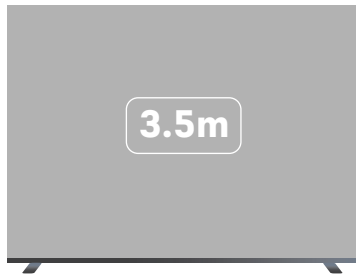

W 3.5m x H 2.5m

	PRODUCT CODE	DESCRIPTION
Hardware Printed Fabric	WSEW35250K	3.5 x 2.5m EDGE backwall kit in a fabricated case
	WSEWFAB35250	3.5 x 2.5m EDGE backwall printed fabric graphics

Product when assembled : W 3500mm x H 2500mm x D 600mm

Transport Case : Extra Large Poly Case - 46 kg

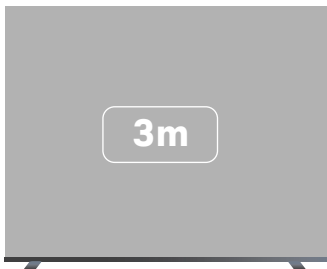

W 3m x H 2.5m

	PRODUCT CODE	DESCRIPTION
Hardware Printed Fabric	WSEW30250K	3 x 2.5m EDGE backwall kit in a fabricated case
	WSEWFAB30250	3 x 2.5m EDGE backwall printed fabric graphics

Product when assembled : W 3000mm x H 2500mm x D 600mm

Transport Case : Large Poly Case - 40 kg

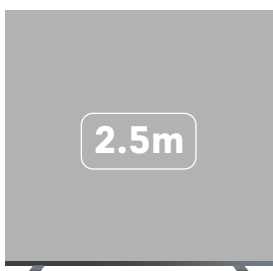

W 2.5m x H 2.5m

	PRODUCT CODE	DESCRIPTION
Hardware Printed Fabric	WSEW25250K	2.5 x 2.5m EDGE backwall kit in a fabricated case
	WSEWFAB25250	2.5 x 2.5m EDGE backwall printed fabric graphics

Product when assembled : W 2500mm x H 2500mm x D 600mm

Transport Case : Extra Large Poly Case - 38 kg

*Custom sizes are available on request.

BACKWALL CODES (2.5M HIGH)

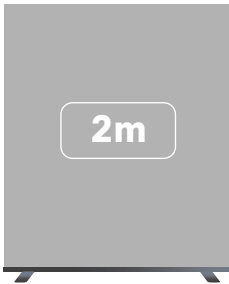

W 2m x H 2.5m

	PRODUCT CODE	DESCRIPTION
Hardware Printed Fabric	WSEW20250K	2 x 2.5m EDGE backwall kit in a fabricated case
	WSEWFAB20250	2 x 2.5m EDGE backwall printed fabric graphics

Product when assembled : W 2000mm x H 2500mm x D 600mm

Transport Case : Extra Large Poly Case - 35 kg

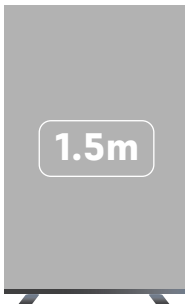

W 1.5m x H 2.5m

	PRODUCT CODE	DESCRIPTION
Hardware Printed Fabric	WSEW15250K	1.5 x 2.5m EDGE backwall kit in a fabricated case
	WSEWFAB15250	1.5 x 2.5m EDGE backwall printed fabric graphics

Product when assembled : W 1500mm x H 2500mm x D 600mm

Transport Case : Small Poly Case - 32 kg



W 1m x H 2.5m

	PRODUCT CODE	DESCRIPTION
Hardware Printed Fabric	WSEW10250K	1 x 2.5m EDGE backwall kit in a fabricated case
	WSEWFAB10250	1 x 2.5m EDGE backwall printed fabric graphics

Product when assembled : W 1000mm x H 2500mm x D 600mm

Transport Case : Small Poly Case - 27 kg

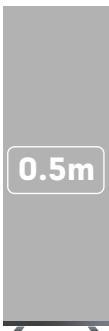

W 0.5m x H 2.5m

	PRODUCT CODE	DESCRIPTION
Hardware Printed Fabric	WSEW05250K	0.5 x 2.5m EDGE backwall kit in a fabricated case
	WSEWFAB05250	0.5 x 2.5m EDGE backwall printed fabric graphics

Product when assembled : W 500mm x H 2500mm x D 600mm

Transport Case : Small Poly Case - 25 kg

BACKWALL CODES (3M HIGH)

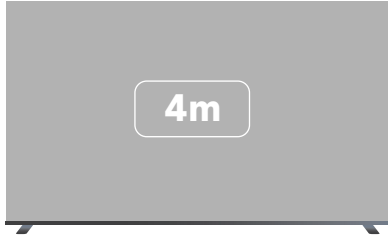

W 4m x H 3m

	PRODUCT CODE	DESCRIPTION
Hardware Printed Fabric	WSEW40300K	4 x 3m EDGE backwall kit in a fabricated case
	WSEWFAB40300	4 x 3m EDGE backwall printed fabric graphics

Product when assembled : W 4000mm x H 3000mm x D 600mm

Transport Case : FlatPack 200 - 57 kg

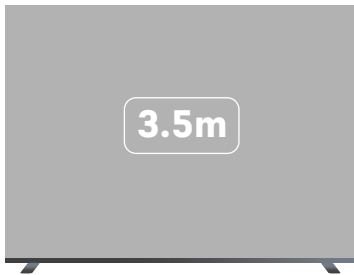

W 3.5m x H 3m

	PRODUCT CODE	DESCRIPTION
Hardware Printed Fabric	WSEW35300K	3.5 x 3m EDGE backwall kit in a fabricated case
	WSEWFAB35300	3.5 x 3m EDGE backwall printed fabric graphics

Product when assembled : W 3500mm x H 3000mm x D 600mm

Transport Case : FlatPack 200 - 55 kg

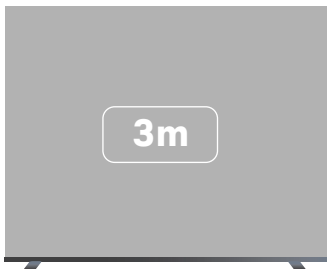

W 3m x H 3m

	PRODUCT CODE	DESCRIPTION
Hardware Printed Fabric	WSEW30300K	3 x 3m EDGE backwall kit in a fabricated case
	WSEWFAB30300	3 x 3m EDGE backwall printed fabric graphics

Product when assembled : W 3000mm x H 3000mm x D 600mm

Transport Case : Extra Large Poly Case - 44 kg

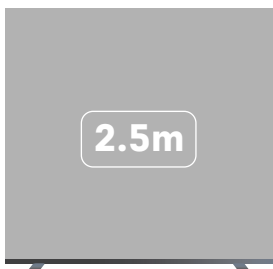

W 2.5m x H 3m

	PRODUCT CODE	DESCRIPTION
Hardware Printed Fabric	WSEW25300K	2.5 x 3m EDGE backwall kit in a fabricated case
	WSEWFAB25300	2.5 x 3m EDGE backwall printed fabric graphics

Product when assembled : W 2500mm x H 3000mm x D 600mm

Transport Case : Extra Large Poly Case - 42 kg

*Custom sizes are available on request.

BACKWALL CODES (3M HIGH)

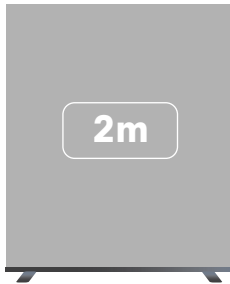

W 2m x H 3m

	PRODUCT CODE	DESCRIPTION
Hardware Printed Fabric	WSEW20300K	2 x 3m EDGE backwall kit in a fabricated case
	WSEWFAB20300	2 x 3m EDGE backwall printed fabric graphics

Product when assembled : W 2000mm x H 3000mm x D 600mm

Transport Case : Large Poly Case - 38 kg

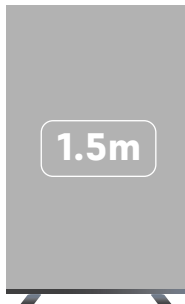

W 1.5m x H 3m

	PRODUCT CODE	DESCRIPTION
Hardware Printed Fabric	WSEW15300K	1.5 x 3m EDGE backwall kit in a fabricated case
	WSEWFAB15300	1.5 x 3m EDGE backwall printed fabric graphics

Product when assembled : W 1500mm x H 3000mm x D 600mm

Transport Case : Large Poly Case - 36 kg



W 1m x H 3m

	PRODUCT CODE	DESCRIPTION
Hardware Printed Fabric	WSEW10300K	1 x 3m EDGE backwall kit in a fabricated case
	WSEWFAB10300	1 x 3m EDGE backwall printed fabric graphics

Product when assembled : W 1000mm x H 3000mm x D 600mm

Transport Case : Large Poly Case - 30 kg

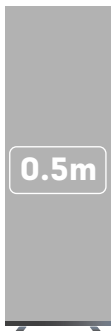

W 0.5m x H 3m

	PRODUCT CODE	DESCRIPTION
Hardware Printed Fabric	WSEW05300K	0.5 x 3m EDGE backwall kit in a fabricated case
	WSEWFAB05300	0.5 x 3m EDGE backwall printed fabric graphics

Product when assembled : W 500mm x H 3000mm x D 600mm

Transport Case : Small Poly Case - 28 kg

CORNER



SPECIFICALLY DESIGNED TO FIT YOUR FLOOR SPACE

EDGE corner walls come in a range of sizes which combine together to make the most of your exhibition floor spaces. Each wall comes equipped with offset baseplate's which allows your stand to fit within the floor space.

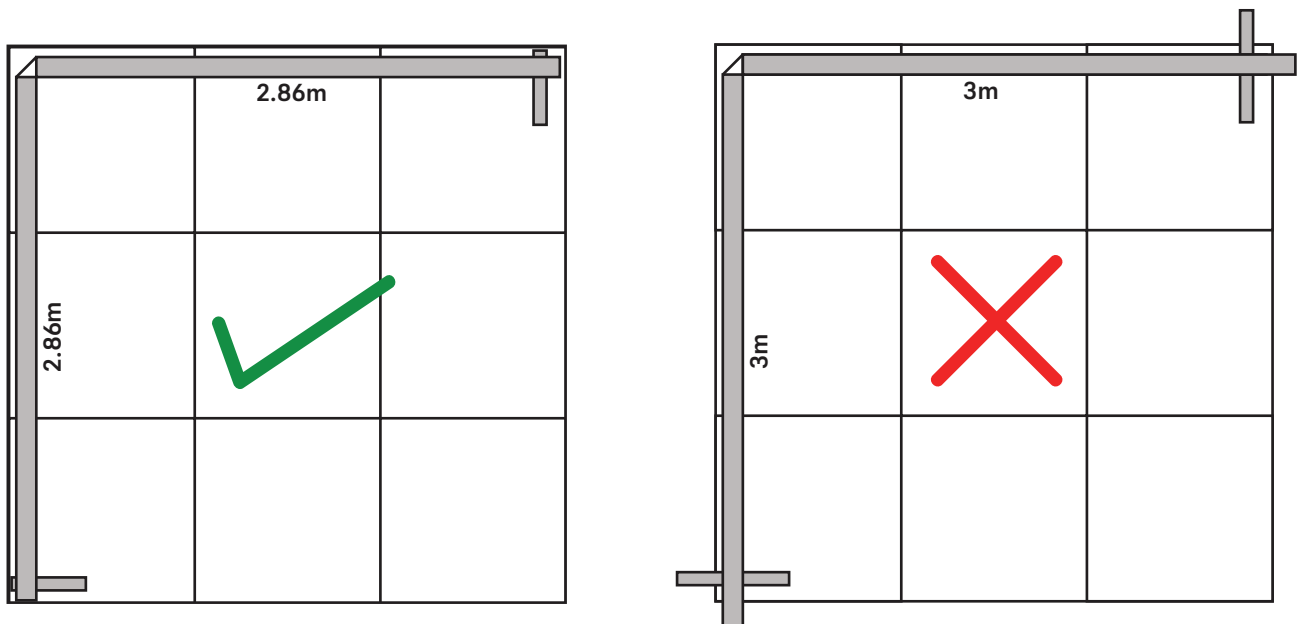

EXTERNAL CORNER



'Y' EXTERNAL CONNECTOR

Our 'Y' external connectors ensures minimal interruption to your graphics allowing them to continue around the corner.

EXTERNAL CORNER CONNECTION - Y

HEIGHT	PRODUCT CODE	DESCRIPTION
2.36m	WSLKCK77Y236	EDGE "Y" Corner Connection Kit - 2,360mm
2.5m	WSLKCK77Y250	EDGE "Y" Corner Connection Kit - 2,500mm
3m	WSLKCK77Y300	EDGE "Y" Corner Connection Kit - 3,000mm



'TRIANGLE' EXTERNAL CONNECTOR

Our 'triangle' external connectors provide a smooth, sleek, channel free finish to external corners.

EXTERNAL CORNER CONNECTION - TRIANGLE

HEIGHT	PRODUCT CODE	DESCRIPTION
Silver - Anodised		
2.36m	WSLKCK77T236A	EDGE Triangular Corner Connection Kit, Anodised - 2,360mm
2.5m	WSLKCK77T250A	EDGE Triangular Corner Connection Kit, Anodised - 2,500mm
3m	WSLKCK77T300A	EDGE Triangular Corner Connection Kit, Anodised - 3,000mm

White - Powder Coated

2.36m	WSLKCK77T236W	EDGE Triangular Corner Connection Kit, White - 2,360mm
2.5m	WSLKCK77T250W	EDGE Triangular Corner Connection Kit, White - 2,500mm
3m	WSLKCK77T300W	EDGE Triangular Corner Connection Kit, White - 3,000mm

Black - Powder Coated

2.36m	WSLKCK77T236B	EDGE Triangular Corner Connection Kit, Black - 2,360mm
2.5m	WSLKCK77T250B	EDGE Triangular Corner Connection Kit, Black - 2,500mm
3m	WSLKCK77T300B	EDGE Triangular Corner Connection Kit, Black - 3,000mm

Available in:

Powder Coated Anodised





Black White Silver

INTERNAL CORNER

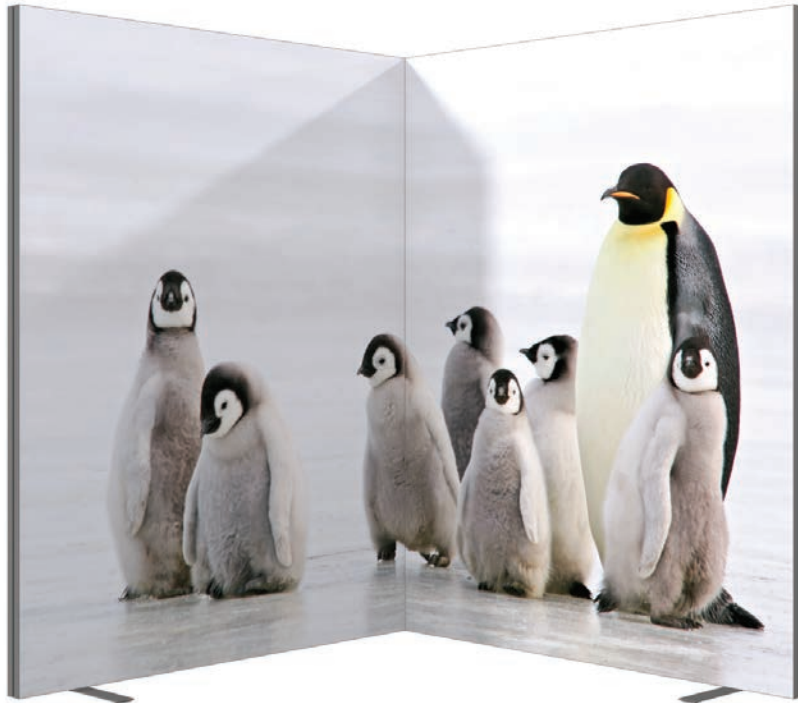

Our internal connectors ensure a perfect 90 degree corner every time.
They are small and compact making them simple to install.

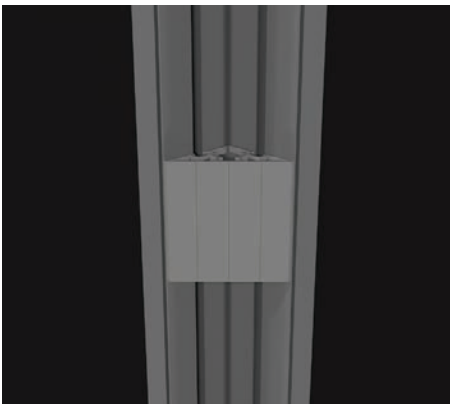

INTERNAL CORNER CONNECTION

HEIGHT	PRODUCT CODE	DESCRIPTION
2.36m	WSLKCK1236	EDGE Internal Corner Connection Kit - 2,360mm
2.5m	WSLKCK1250	EDGE Internal Corner Connection Kit - 2,500mm
3m	WSLKCK1300	EDGE Internal Corner Connection Kit - 3,000mm

CORNER CODES (2.36M HIGH)

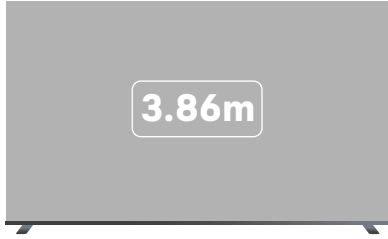

W 3.86m x H 2.36m

	PRODUCT CODE	DESCRIPTION
Hardware Printed Fabric	WSEW386236K	3.86 x 2.36m EDGE backwall kit in a fabricated case
	WSEWFAB386236	3.86 x 2.36m EDGE backwall printed fabric graphics

Product when assembled : W 3860mm x H 2360mm x D 400mm

Transport Case : Extra Large Poly Case - 47 kg

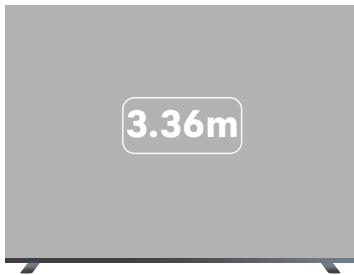

W 3.36m x H 2.36m

	PRODUCT CODE	DESCRIPTION
Hardware Printed Fabric	WSEW336236K	3.36 x 2.36m EDGE backwall kit in a fabricated case
	WSEWFAB336236	3.36 x 2.36m EDGE backwall printed fabric graphics

Product when assembled : W 3360mm x H 2360mm x D 400mm

Transport Case : Extra Large Poly Case - 45 kg

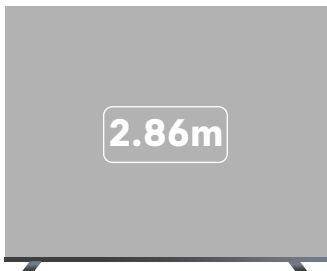

W 2.86m x H 2.36m

	PRODUCT CODE	DESCRIPTION
Hardware Printed Fabric	WSEW286236K	2.86 x 2.36m EDGE backwall kit in a fabricated case
	WSEWFAB286236	2.86 x 2.36m EDGE backwall printed fabric graphics

Product when assembled : W 2860mm x H 2360mm x D 400mm

Transport Case : Large Poly Case - 39 kg

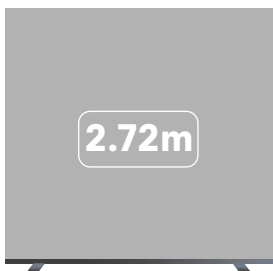

W 2.72m x H 2.36m

	PRODUCT CODE	DESCRIPTION
Hardware Printed Fabric	WSEW272236K	2.27 x 2.36m EDGE backwall kit in a fabricated case
	WSEWFAB272236	2.27 x 2.36m EDGE backwall printed fabric graphics

Product when assembled : W 2720mm x H 2360mm x D 400mm

Transport Case : Large Poly Case - 39 kg

CORNER CODES (2.36M HIGH)

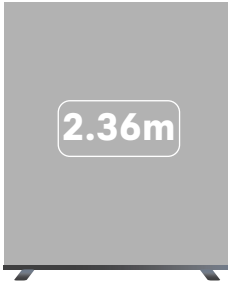

W 2.36m x H 2.36m

	PRODUCT CODE	DESCRIPTION
Hardware Printed Fabric	WSEW236236K	2.36 x 2.36m EDGE backwall kit in a fabricated case
	WSEWFAB236236	2.36 x 2.36m EDGE backwall printed fabric graphics

Product when assembled : W 2360mm x H 2360mm x D 400mm

Transport Case : Large Poly Case - 37 kg

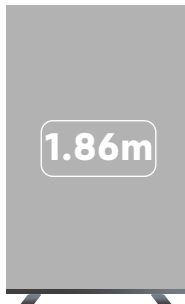

W 1.86m x H 2.36m

	PRODUCT CODE	DESCRIPTION
Hardware Printed Fabric	WSEW186236K	1.86 x 2.36m EDGE backwall kit in a fabricated case
	WSEWFAB186236	1.86 x 2.36m EDGE backwall printed fabric graphics

Product when assembled : W 1860mm x H 2360mm x D 400mm

Transport Case : Large Poly Case - 32 kg



W 1.36m x H 2.36m

	PRODUCT CODE	DESCRIPTION
Hardware Printed Fabric	WSEW136236K	1.36 x 2.36m EDGE backwall kit in a fabricated case
	WSEWFAB136236	1.36 x 2.36m EDGE backwall printed fabric graphics

Product when assembled : W 1360mm x H 2360mm x D 400mm

Transport Case : Small Poly Case - 31 kg



W 0.86m x H 2.36m

	PRODUCT CODE	DESCRIPTION
Hardware Printed Fabric	WSEW86236K	0.86 x 2.36m EDGE backwall kit in a fabricated case
	WSEWFAB86236	0.86 x 2.36m EDGE backwall printed fabric graphics

Product when assembled : W 860mm x H 2360mm x D 400mm

Transport Case : Small Poly Case - 23 kg

*Custom sizes are available on request.

BACKWALL CODES (2.5M HIGH)

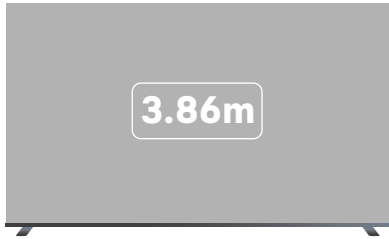

W 3.86m x H 2.5m

	PRODUCT CODE	DESCRIPTION
Hardware Printed Fabric	WSEW386250K	3.86 x 2.5m EDGE backwall kit in a fabricated case
	WSEWFAB386250	3.86 x 2.5m EDGE backwall printed fabric graphics

Product when assembled : W 3860mm x H 2500mm x D 400mm

Transport Case : Extra Large Poly Case - 48 kg

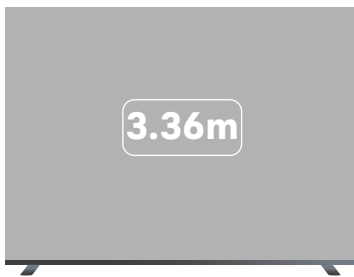

W 3.36m x H 2.5m

	PRODUCT CODE	DESCRIPTION
Hardware Printed Fabric	WSEW336250K	3.36 x 2.5m EDGE backwall kit in a fabricated case
	WSEWFAB336250	3.36 x 2.5m EDGE backwall printed fabric graphics

Product when assembled : W 3360mm x H 2500mm x D 400mm

Transport Case : Extra Large Poly Case - 46 kg

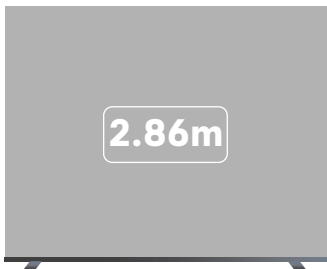

W 2.86m x H 2.5m

	PRODUCT CODE	DESCRIPTION
Hardware Printed Fabric	WSEW286250K	2.86 x 2.5m EDGE backwall kit in a fabricated case
	WSEWFAB286250	2.86 x 2.5m EDGE backwall printed fabric graphics

Product when assembled : W 2860mm x H 2500mm x D 400mm

Transport Case : Large Poly Case - 40 kg

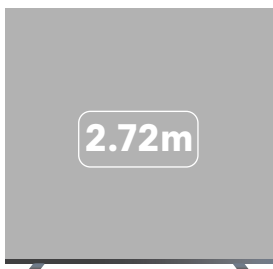

W 2.72m x H 2.5m

	PRODUCT CODE	DESCRIPTION
Hardware Printed Fabric	WSEW272250K	2.72 x 2.5m EDGE backwall kit in a fabricated case
	WSEWFAB272250	2.72 x 2.5m EDGE backwall printed fabric graphics

Product when assembled : W 2720mm x H 2500mm x D 400mm

Transport Case : Large Poly Case - 39 kg

BACKWALL CODES (2.5M HIGH)

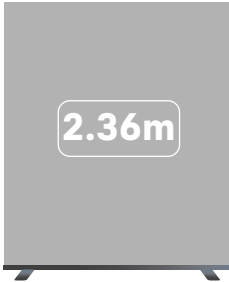

W 2.36m x H 2.5m

	PRODUCT CODE	DESCRIPTION
Hardware Printed Fabric	WSEW236250K	2.36 x 2.5m EDGE backwall kit in a fabricated case
	WSEWFAB236250	2.36 x 2.5m EDGE backwall printed fabric graphics

Product when assembled : W 2360mm x H 2500mm x D 400mm

Transport Case : Extra Large Poly Case - 38 kg

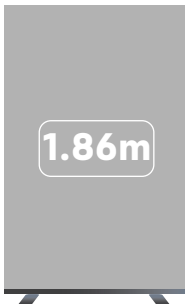

W 1.86m x H 2.5m

	PRODUCT CODE	DESCRIPTION
Hardware Printed Fabric	WSEW186250K	1.86 x 2.5m EDGE backwall kit in a fabricated case
	WSEWFAB186250	1.86 x 2.5m EDGE backwall printed fabric graphics

Product when assembled : W 1860mm x H 2500mm x D 400mm

Transport Case : Large Poly Case - 35 kg



W 1.36m x H 2.5m

	PRODUCT CODE	DESCRIPTION
Hardware Printed Fabric	WSEW136250K	1.36 x 2.5m EDGE backwall kit in a fabricated case
	WSEWFAB136250	1.36 x 2.5m EDGE backwall printed fabric graphics

Product when assembled : W 1360mm x H 2500mm x D 400mm

Transport Case : Small Poly Case - 32 kg



W 0.86m x H 2.5m

	PRODUCT CODE	DESCRIPTION
Hardware Printed Fabric	WSEW86250K	0.86 x 2.5m EDGE backwall kit in a fabricated case
	WSEWFAB86250	0.86 x 2.5m EDGE backwall printed fabric graphics

Product when assembled : W 860mm x H 2500mm x D 400mm

Transport Case : Small Poly Case - 27 kg

*Custom sizes are available on request.

BACKWALL CODES (3M HIGH)

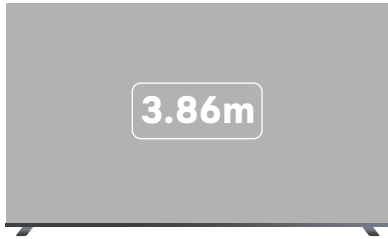

W 3.86m x H 3m

	PRODUCT CODE	DESCRIPTION
Hardware Printed Fabric	WSEW386300K	3.86 x 3m EDGE backwall kit in a fabricated case
	WSEWFAB386300	3.86 x 3m EDGE backwall printed fabric graphics

Product when assembled : W 3860mm x H 3000mm x D 400mm

Transport Case : FlatPack 200 - 54 kg

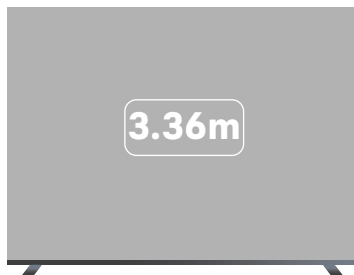

W 3.36m x H 3m

	PRODUCT CODE	DESCRIPTION
Hardware Printed Fabric	WSEW336300K	3.36 x 3m EDGE backwall kit in a fabricated case
	WSEWFAB336300	3.36 x 3m EDGE backwall printed fabric graphics

Product when assembled : W 3360mm x H 3000mm x D 400mm

Transport Case : FlatPack 200 - 52 kg

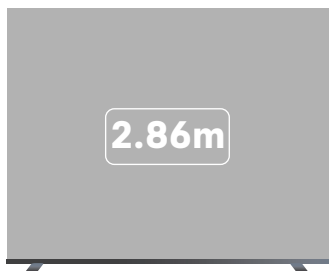

W 2.86m x H 3m

	PRODUCT CODE	DESCRIPTION
Hardware Printed Fabric	WSEW286300K	2.86 x 3m EDGE backwall kit in a fabricated case
	WSEWFAB286300	2.86 x 3m EDGE backwall printed fabric graphics

Product when assembled : W 2860mm x H 3000mm x D 400mm

Transport Case : Extra Large Poly Case - 44 kg

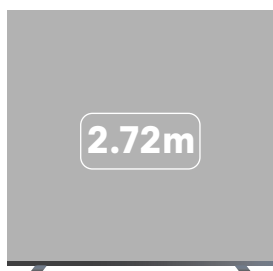

W 2.72m x H 3m

	PRODUCT CODE	DESCRIPTION
Hardware Printed Fabric	WSEW272300K	2.72 x 3m EDGE backwall kit in a fabricated case
	WSEWFAB272300	2.72 x 3m EDGE backwall printed fabric graphics

Product when assembled : W 2720mm x H 3000mm x D 400mm

Transport Case : Extra Large Poly Case - 43 kg

BACKWALL CODES (3M HIGH)

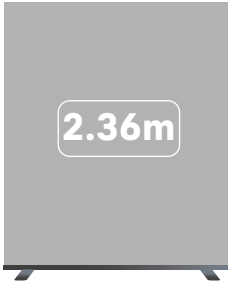

2.36m

W 2.36m x H 3m

	PRODUCT CODE	DESCRIPTION
Hardware Printed Fabric	WSEW236300K	2.36 x 3m EDGE backwall kit in a fabricated case
	WSEWFAB236300	2.36 x 3m EDGE backwall printed fabric graphics

Product when assembled : W 2360mm x H 3000mm x D 400mm

Transport Case : Large Poly Case - 41 kg

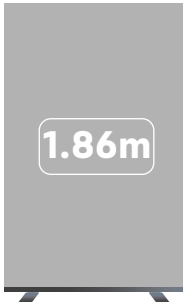

1.86m

W 1.86m x H 3m

	PRODUCT CODE	DESCRIPTION
Hardware Printed Fabric	WSEW186300K	1.86 x 3m EDGE backwall kit in a fabricated case
	WSEWFAB186300	1.86 x 3m EDGE backwall printed fabric graphics

Product when assembled : W 1860mm x H 3000mm x D 400mm

Transport Case : Large Poly Case - 38 kg

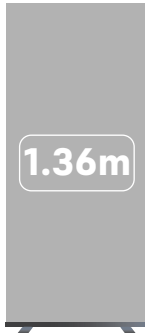

1.36m

W 1.36m x H 3m

	PRODUCT CODE	DESCRIPTION
Hardware Printed Fabric	WSEW136300K	1.72 x 3m EDGE backwall kit in a fabricated case
	WSEWFAB136300	1.72 x 3m EDGE backwall printed fabric graphics

Product when assembled : W 1360mm x H 3000mm x D 400mm

Transport Case : Large Poly Case - 36 kg

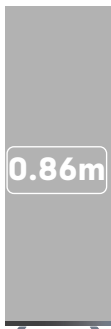

0.86m

W 0.86m x H 3m

	PRODUCT CODE	DESCRIPTION
Hardware Printed Fabric	WSEW86300K	0.86 x 3m EDGE backwall kit in a fabricated case
	WSEWFAB86300	0.86 x 3m EDGE backwall printed fabric graphics

Product when assembled : W 860mm x H 3000mm x D 400mm

Transport Case : Small Poly Case - 29 kg

*Custom sizes are available on request.

SUMMARY BACKWALL

2.36m High

PRODUCT CODE	DESCRIPTION
WSEW40236K	4 x 2.36m EDGE backwall kit in a fabricated case
WSEWFAB40236	4 x 2.36m EDGE backwall printed fabric graphic
WSEW35236K	3.5 x 2.36m EDGE backwall kit in a fabricated case
WSEWFAB35236	3.5 x 2.36m EDGE backwall printed fabric graphic
WSEW30236K	3 x 2.36m EDGE backwall kit in a fabricated case
WSEWFAB30236	3 x 2.36m EDGE backwall printed fabric graphic
WSEW25236K	2.5 x 2.36m EDGE backwall kit in a fabricated case
WSEWFAB25236	2.5 x 2.36m EDGE backwall printed fabric graphic
WSEW20236K	2 x 2.36m EDGE backwall kit in a fabricated case
WSEWFAB20236	2 x 2.36m EDGE backwall printed fabric graphic
WSEW15236K	1.5 x 2.36m EDGE backwall kit in a fabricated case
WSEWFAB15236	1.5 x 2.36m EDGE backwall printed fabric graphic
WSEW10236K	1 x 2.36m EDGE backwall kit in a fabricated case
WSEWFAB10236	1 x 2.36m EDGE backwall printed fabric graphic
WSEW05236K	0.5 x 2.36m EDGE backwall kit in a fabricated case
WSEWFAB05236	0.5 x 2.36m EDGE backwall printed fabric graphic

2.5m High

PRODUCT CODE	DESCRIPTION
WSEW40250K	4 x 2.5m EDGE backwall kit in a fabricated case
WSEWFAB40250	4 x 2.5m EDGE backwall printed fabric graphic
WSEW35250K	3.5 x 2.5m EDGE backwall kit in a fabricated case
WSEWFAB35250	3.5 x 2.5m EDGE backwall printed fabric graphic
WSEW30250K	3 x 2.5m EDGE backwall kit in a fabricated case
WSEWFAB30250	3 x 2.5m EDGE backwall printed fabric graphic
WSEW25250K	2.5 x 2.5m EDGE backwall kit in a fabricated case
WSEWFAB25250	2.5 x 2.5m EDGE backwall printed fabric graphic
WSEW20250K	2 x 2.5m EDGE backwall kit in a fabricated case
WSEWFAB20250	2 x 2.5m EDGE backwall printed fabric graphic
WSEW15250K	1.5 x 2.5m EDGE backwall kit in a fabricated case
WSEWFAB15250	1.5 x 2.5m EDGE backwall printed fabric graphic
WSEW10250K	1 x 2.5m EDGE backwall kit in a fabricated case
WSEWFAB10250	1 x 2.5m EDGE backwall printed fabric graphic
WSEW05250K	0.5 x 2.5m EDGE backwall kit in a fabricated case
WSEWFAB05250	0.5 x 2.5m EDGE backwall printed fabric graphic

SUMMARY BACKWALL

3m High

PRODUCT CODE	DESCRIPTION
WSEW40300K	4 x 3m EDGE backwall kit in a fabricated case
WSEWFAB40300	4 x 3m EDGE backwall printed fabric graphic
WSEW35300K	3.5 x 3m EDGE backwall kit in a fabricated case
WSEWFAB35300	3.5 x 3m EDGE backwall printed fabric graphic
WSEW30300K	3 x 3m EDGE backwall kit in a fabricated case
WSEWFAB30300	3 x 3m EDGE backwall printed fabric graphic
WSEW25300K	2.5 x 3m EDGE backwall kit in a fabricated case
WSEWFAB25300	2.5 x 3m EDGE backwall printed fabric graphic
WSEW20300K	2 x 3m EDGE backwall kit in a fabricated case
WSEWFAB20300	2 x 3m EDGE backwall printed fabric graphic
WSEW15300K	1.5 x 3m EDGE backwall kit in a fabricated case
WSEWFAB15300	1.5 x 3m EDGE backwall printed fabric graphic
WSEW10300K	1 x 3m EDGE backwall kit in a fabricated case
WSEWFAB10300	1 x 3m EDGE backwall printed fabric graphic
WSEW05300K	0.5 x 3m EDGE backwall kit in a fabricated case
WSEWFAB05300	0.5 x 3m EDGE backwall printed fabric graphic

SUMMARY CORNER

2.36m High

PRODUCT CODE	DESCRIPTION
WSEW386236K	3.86 x 2.36m EDGE backwall kit in a fabricated case
WSEWFAB386236	3.86 x 2.36m EDGE backwall printed fabric graphic
WSEW336236K	3.36 x 2.36m EDGE backwall kit in a fabricated case
WSEWFAB336236	3.36 x 2.36m EDGE backwall printed fabric graphic
WSEW286236K	2.86 x 2.36m EDGE backwall kit in a fabricated case
WSEWFAB286236	2.86 x 2.36m EDGE backwall printed fabric graphic
WSEW272236K	2.72 x 2.36m EDGE backwall kit in a fabricated case
WSEWFAB272236	2.72 x 2.36m EDGE backwall printed fabric graphic
WSEW236236K	2.36 x 2.36m EDGE backwall kit in a fabricated case
WSEWFAB236236	2.36 x 2.36m EDGE backwall printed fabric graphic
WSEW186236K	1.86 x 2.36m EDGE backwall kit in a fabricated case
WSEWFAB186236	1.86 x 2.36m EDGE backwall printed fabric graphic
WSEW136236K	1.36 x 2.36m EDGE backwall kit in a fabricated case
WSEWFAB136236	1.36 x 2.36m EDGE backwall printed fabric graphic
WSEW86236K	0.86 x 2.36m EDGE backwall kit in a fabricated case
WSEWFAB86236	0.86 x 2.36m EDGE backwall printed fabric graphic

2.5m High

PRODUCT CODE	DESCRIPTION
WSEW386250K	3.86 x 2.5m EDGE backwall kit in a fabricated case
WSEWFAB386250	3.86 x 2.5m EDGE backwall printed fabric graphic
WSEW336250K	3.36 x 2.5m EDGE backwall kit in a fabricated case
WSEWFAB336250	3.36 x 2.5m EDGE backwall printed fabric graphic
WSEW286250K	2.86 x 2.5m EDGE backwall kit in a fabricated case
WSEWFAB286250	2.86 x 2.5m EDGE backwall printed fabric graphic
WSEW272250K	2.72 x 2.5m EDGE backwall kit in a fabricated case
WSEWFAB272250	2.72 x 2.5m EDGE backwall printed fabric graphic
WSEW236250K	2.36 x 2.5m EDGE backwall kit in a fabricated case
WSEWFAB236250	2.36 x 2.5m EDGE backwall printed fabric graphic
WSEW186250K	1.86 x 2.5m EDGE backwall kit in a fabricated case
WSEWFAB186250	1.86 x 2.5m EDGE backwall printed fabric graphic
WSEW136250K	1.36 x 2.5m EDGE backwall kit in a fabricated case
WSEWFAB136250	1.36 x 2.5m EDGE backwall printed fabric graphic
WSEW86250K	0.86 x 2.5m EDGE backwall kit in a fabricated case
WSEWFAB86250	0.86 x 2.5m EDGE backwall printed fabric graphic

SUMMARY BACKWALL

3m High

PRODUCT CODE	DESCRIPTION
WSEW386300K	3.86 x 3m EDGE backwall kit in a fabricated case
WSEWFAB386300	3.86 x 3m EDGE backwall printed fabric graphic
WSEW336300K	3.36 x 3m EDGE backwall kit in a fabricated case
WSEWFAB336300	3.36 x 3m EDGE backwall printed fabric graphic
WSEW286300K	2.86 x 3m EDGE backwall kit in a fabricated case
WSEWFAB286300	2.86 x 3m EDGE backwall printed fabric graphic
WSEW272300K	2.72 x 3m EDGE backwall kit in a fabricated case
WSEWFAB272300	2.72 x 3m EDGE backwall printed fabric graphic
WSEW236300K	2.36 x 3m EDGE backwall kit in a fabricated case
WSEWFAB236300	2.36 x 3m EDGE backwall printed fabric graphic
WSEW186300K	1.86 x 3m EDGE backwall kit in a fabricated case
WSEWFAB186300	1.86 x 3m EDGE backwall printed fabric graphic
WSEW136300K	1.36 x 3m EDGE backwall kit in a fabricated case
WSEWFAB136300	1.36 x 3m EDGE backwall printed fabric graphic
WSEW86300K	0.86 x 3m EDGE backwall kit in a fabricated case
WSEWFAB86300	0.86 x 3m EDGE backwall printed fabric graphic

TOWER

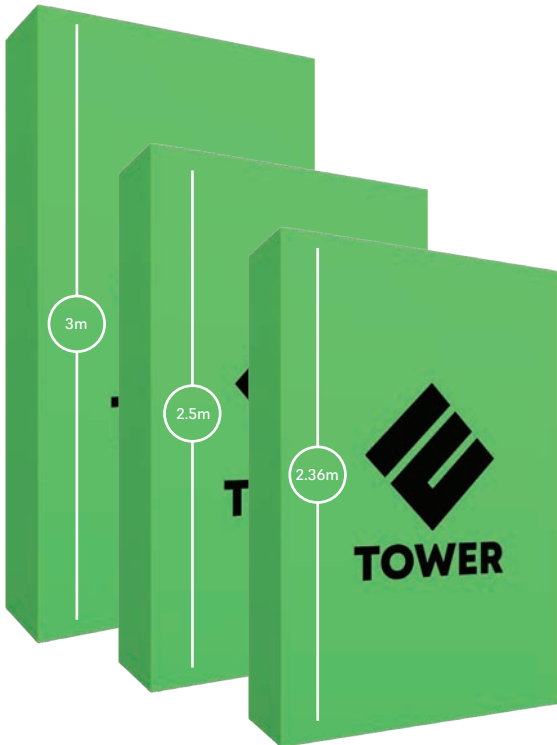
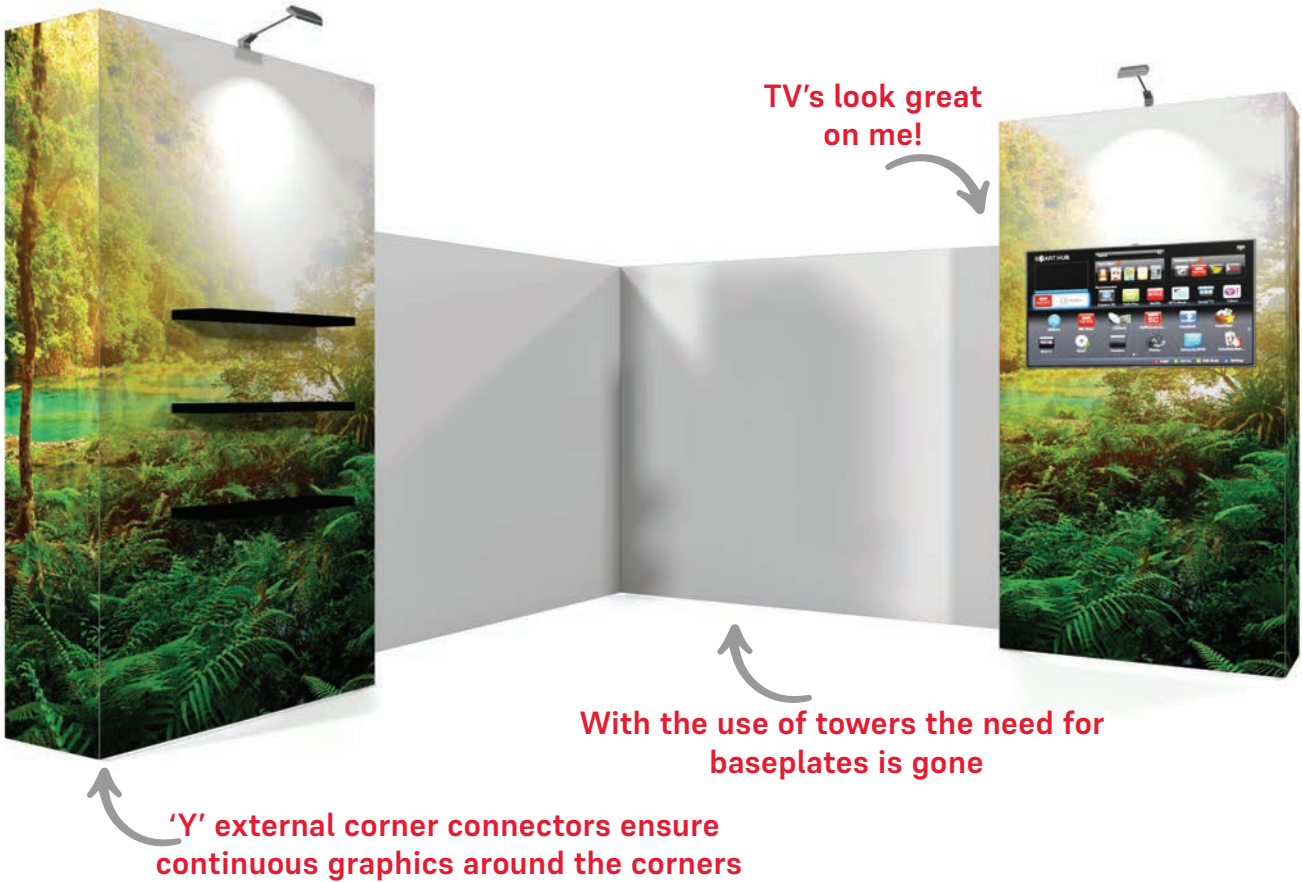

RANGE OF HEIGHTS

All our EDGE towers are available in a range of 3 heights as standard - 2.36m, 2.5m & an eye catching 3m high.

Integrate the 2.36m towers with your existing Nomadic products, stand eye to eye with competitors offering 2.5m solutions or soar over them with our impressive 3m high range.

Purchase a 2.36m tower today but know that tomorrow, based on the unique modularity of the range, this purchase can scale up in height to 3m.

TOWER CODES (2.36M HIGH)

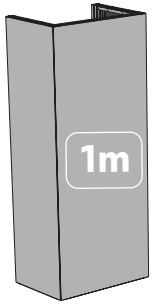

W 1m x D 0.64m x H 2.36m

	PRODUCT CODE	DESCRIPTION
Hardware Printed Fabric	WSET10236	1 x 2.36m EDGE tower kit
	WSETFAB10236	1 x 2.36m EDGE tower fabric graphics

Product when assembled : W 1000mm x H 2360mm x D 640mm

Transport Case : FlatPack 200 & Large Poly Case

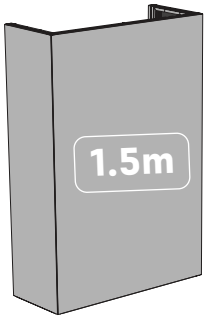

W 1.5m x D 0.64m x H 2.36m

	PRODUCT CODE	DESCRIPTION
Hardware Printed Fabric	WSET15236	1.5 x 2.36m EDGE tower kit
	WSETFAB15236	1.5 x 2.36m EDGE tower fabric graphics

Product when assembled : W 1500mm x H 2360mm x D 640mm

Transport Case : FlatPack 200 & Large Poly Case

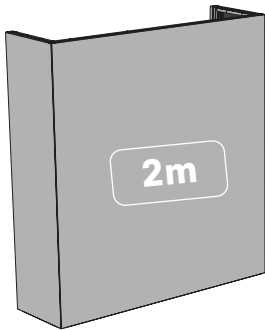

W 2m x D 0.64m x H 2.36m

	PRODUCT CODE	DESCRIPTION
Hardware Printed Fabric	WSET20236	2 x 2.36m EDGE tower kit
	WSETFAB20236	2 x 2.36m EDGE tower fabric graphics

Product when assembled : W 2000mm x H 2360mm x D 640mm

Transport Case : FlatPack 200 & Large Poly Case

*Custom sizes are available on request.

TOWER CODES (2.5M HIGH)

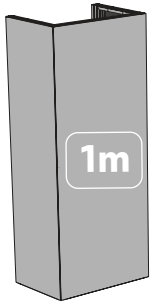

W 1m x D 0.64m x H 2.5m

	PRODUCT CODE	DESCRIPTION
Hardware Printed Fabric	WSET10250	1 x 2.5m EDGE tower kit
	WSETFAB10250	1 x 2.5m EDGE tower fabric graphics

Product when assembled : W 1000mm x H 2500mm x D 640mm

Transport Case : FlatPack 200 & Large Poly Case

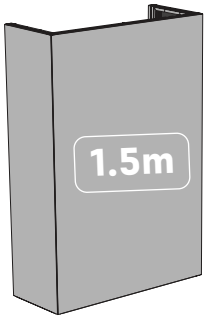

W 1.5m x D 0.64m x H 2.5m

	PRODUCT CODE	DESCRIPTION
Hardware Printed Fabric	WSET15250	1.5 x 2.5m EDGE tower kit
	WSETFAB15250	1.5 x 2.5m EDGE tower fabric graphics

Product when assembled : W 1500mm x H 2500mm x D 640mm

Transport Case : FlatPack 200 & Large Poly Case

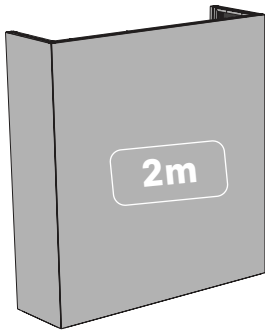

W 2m x D 0.64m x H 2.5m

	PRODUCT CODE	DESCRIPTION
Hardware Printed Fabric	WSET20250	2 x 2.5m EDGE tower kit
	WSETFAB20250	2 x 2.5m EDGE tower fabric graphics

Product when assembled : W 2000mm x H 2500mm x D 640mm

Transport Case : FlatPack 200 & Large Poly Case

TOWER CODES (3M HIGH)

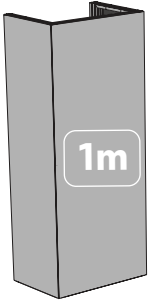

W 1m x D 0.64m x H 3m

	PRODUCT CODE	DESCRIPTION
Hardware Printed Fabric	WSET10300	1 x 3m EDGE tower kit
	WSETFAB10300	1 x 3m EDGE tower fabric graphics

Product when assembled : W 1000mm x H 3000mm x D 640mm

Transport Case : FlatPack 300 & Large Poly Case

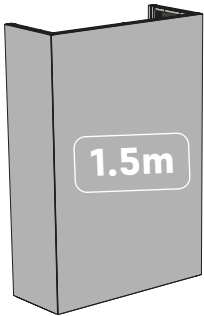

W 1.5m x D 0.64m x H 3m

	PRODUCT CODE	DESCRIPTION
Hardware Printed Fabric	WSET15300	1.5 x 3m EDGE tower kit
	WSETFAB15300	1.5 x 3m EDGE tower fabric graphics

Product when assembled : W 1500mm x H 3000mm x D 640mm

Transport Case : FlatPack 300 & Extra Large Poly Case

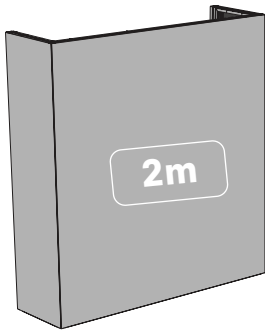

W 2m x D 0.64m x H 3m

	PRODUCT CODE	DESCRIPTION
Hardware Printed Fabric	WSET20300	2 x 3m EDGE tower kit
	WSETFAB20300	2 x 3m EDGE tower fabric graphics

Product when assembled : W 2000mm x H 3000mm x D 640mm

Transport Case : FlatPack 300 & Extra Large Poly Case

*Custom sizes are available on request.

BACKLIT TOWER



We have combined all of the features of our EDGE towers with the brilliance of our LED backlit BrightWall 80 display walls. EDGE backlit towers feature a fully backlit front wall to grab the viewers attention!

UPGRADE

Our backlit EDGE towers use 2 external triangle connectors on the front of the tower. As standard these are finished anodised (silver), however you can upgrade to a sleeker powder coated finish (white/black) using the code below.



PRODUCT CODE	DESCRIPTION
KBEUPPCTRI77	Upgrade to Powder Coated Triangular Extrusion (per corner)

BACKLIT TOWER CODES (2.36M HIGH)

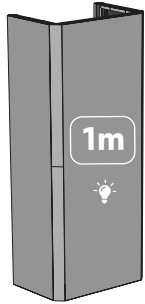

W 1m x D 0.64m x H 2.36m

	PRODUCT CODE	DESCRIPTION
Hardware	WSET10236BL	1 x 2.36m EDGE backlit tower kit
Printed Fabric	WSETFAB10236BL	1 x 2.36m EDGE tower fabric graphics
Lightblocker	WSLKLBL10I80BL	0.86 x 2.36m BrightWall 80 lightblocker panel

Product when assembled : W 1000mm x H 2360mm x D 640mm

Transport Case : FlatPack 200 & Small Poly Case

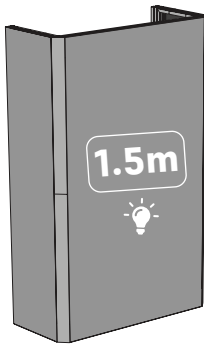

W 1.5m x D 0.64m x H 2.36m

	PRODUCT CODE	DESCRIPTION
Hardware	WSET15236BL	1.5 x 2.36m EDGE backlit tower kit
Printed Fabric	WSETFAB15236BL	1.5 x 2.36m EDGE tower fabric graphics
Lightblocker	WSLKLBL15I80BL	1.36 x 2.36m BrightWall 80 lightblocker panel

Product when assembled : W 1500mm x H 2360mm x D 640mm

Transport Case : FlatPack 200 & Small Poly Case

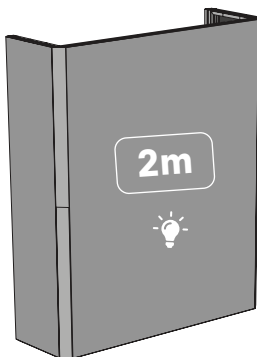

W 2m x D 0.64m x H 2.36m

	PRODUCT CODE	DESCRIPTION
Hardware	WSET20236BL	2 x 2.36m EDGE backlit tower kit
Printed Fabric	WSETFAB20236BL	2 x 2.36m EDGE tower fabric graphics
Lightblocker	WSLKLBL20I80BL	1.86 x 2.36m BrightWall 80 lightblocker panel

Product when assembled : W 2000mm x H 2360mm x D 640mm

Transport Case : FlatPack 200 & Large Poly Case

*Custom sizes are available on request.

BACKLIT TOWER CODES (2.5M HIGH)

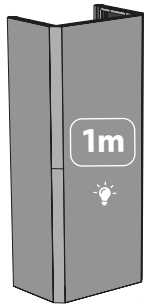

W 1m x D 0.64m x H 2.5m

	PRODUCT CODE	DESCRIPTION
Hardware	WSET10250BL	1 x 2.5m EDGE backlit tower kit
Printed Fabric	WSETFAB10250BL	1 x 2.5m EDGE tower fabric graphics
Lightblocker	WSLKLBL1025I80BL	0.86 x 2.5m BrightWall 80 lightblocker panel

Product when assembled : W 1000mm x H 2500mm x D 640mm

Transport Case : FlatPack 200 & Small Poly Case

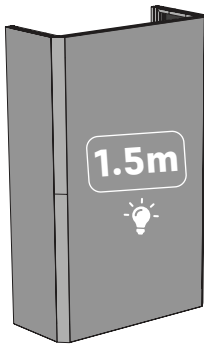

W 1.5m x D 0.64m x H 2.5m

	PRODUCT CODE	DESCRIPTION
Hardware	WSET15250BL	1.5 x 2.5m EDGE backlit tower kit
Printed Fabric	WSETFAB15250BL	1.5 x 2.5m EDGE tower fabric graphics
Lightblocker	WSLKLBL1525I80BL	1.36 x 2.5m BrightWall 80 lightblocker panel

Product when assembled : W 1500mm x H 2500mm x D 640mm

Transport Case : FlatPack 200 & Small Poly Case

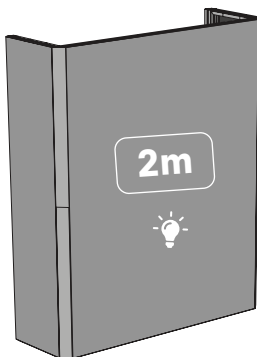

W 2m x D 0.64m x H 2.5m

	PRODUCT CODE	DESCRIPTION
Hardware	WSET20250BL	2 x 2.5m EDGE backlit tower kit
Printed Fabric	WSETFAB20250BL	2 x 2.5m EDGE tower fabric graphics
Lightblocker	WSLKLBL2025I80BL	1.86 x 2.5m BrightWall 80 lightblocker panel

Product when assembled : W 2000mm x H 2500mm x D 640mm

Transport Case : FlatPack 200 & Large Poly Case

BACKLIT TOWER CODES (3M HIGH)

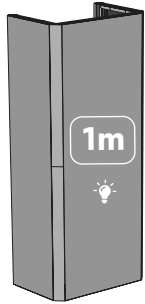

W 1m x D 0.64m x H 3m

	PRODUCT CODE	DESCRIPTION
Hardware	WSET10300BL	1 x 3m EDGE backlit tower kit
Printed Fabric	WSETFAB10300BL	1 x 3m EDGE tower fabric graphics
Lightblocker	WSLKLBL1030180BL	0.86 x 3m BrightWall 80 lightblocker panel

Product when assembled : W 1000mm x H 3000mm x D 640mm

Transport Case : FlatPack 300 & Small Poly Case

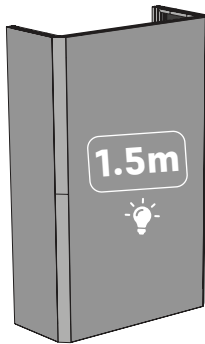

W 1.5m x D 0.64m x H 3m

	PRODUCT CODE	DESCRIPTION
Hardware	WSET15300BL	1.5 x 3m EDGE backlit tower kit
Printed Fabric	WSETFAB15236BL	1.5 x 3m EDGE tower fabric graphics
Lightblocker	WSLKLBL1530180BL	1.36 x 3m BrightWall 80 lightblocker panel

Product when assembled : W 1500mm x H 3000mm x D 640mm

Transport Case : FlatPack 300 & Small Poly Case

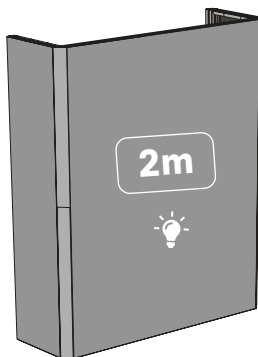

W 2m x D 0.64m x H 3m

	PRODUCT CODE	DESCRIPTION
Hardware	WSET20300BL	2 x 3m EDGE backlit tower kit
Printed Fabric	WSETFAB20300BL	2 x 3m EDGE tower fabric graphics
Lightblocker	WSLKLBL2030180BL	1.86 x 3m BrightWall 80 lightblocker panel

Product when assembled : W 2000mm x H 3000mm x D 640mm

Transport Case : FlatPack 300 & Large Poly Case

*Custom sizes are available on request.

TOWER SUMMARY

2.36m High

PRODUCT CODE	DESCRIPTION
WSET10236	1 x 2.36m EDGE tower kit in 2 transport cases
WSETFAB10236	1 x 2.36m EDGE tower printed fabric graphics
WSET15236	1.5 x 2.36m EDGE tower kit in 2 transport cases
WSETFAB10236	1.5 x 2.36m EDGE tower printed fabric graphics
WSET20236	2 x 2.36m EDGE tower kit in 2 transport cases
WSETFAB10236	2 x 2.36m EDGE tower printed fabric graphics

2.5m High

PRODUCT CODE	DESCRIPTION
WSET10250	1 x 2.5m EDGE tower kit in 2 transport cases
WSETFAB10250	1 x 2.5m EDGE tower printed fabric graphics
WSET15250	1.5 x 2.5m EDGE tower kit in 2 transport cases
WSETFAB10250	1.5 x 2.5m EDGE tower printed fabric graphics
WSET20250	2 x 2.5m EDGE tower kit in 2 transport cases
WSETFAB10250	2 x 2.5m EDGE tower printed fabric graphics

3m High

PRODUCT CODE	DESCRIPTION
WSET10300	1 x 3m EDGE tower kit in 2 transport cases
WSETFAB10300	1 x 3m EDGE tower printed fabric graphics
WSET15300	1.5 x 3m EDGE tower kit in 2 transport cases
WSETFAB10300	1.5 x 3m EDGE tower printed fabric graphics
WSET20300	2 x 3m EDGE tower kit in 2 transport cases
WSETFAB10300	2 x 3m EDGE tower printed fabric graphics

BACKLIT TOWER SUMMARY

2.36m High

PRODUCT CODE	DESCRIPTION
WSET10236BL	1 x 2.36m EDGE tower kit in 2 transport cases
WSETFAB10236	1 x 2.36m EDGE tower printed fabric graphics
WSLKLBL10I80BL	0.86 x 2.36m BrightWall 80 lightblocker panel
WSET15236BL	1.5 x 2.36m EDGE tower kit in 2 transport cases
WSETFAB15236	1.5 x 2.36m EDGE tower printed fabric graphics
WSLKLBL15I80BL	1.36 x 2.36m BrightWall 80 lightblocker panel
WSET20236BL	2 x 2.36m EDGE tower kit in 2 transport cases
WSETFAB20236	2 x 2.36m EDGE tower printed fabric graphics
WSLKLBL20I80BL	1.86 x 2.36m BrightWall 80 lightblocker panel

2.5m High

PRODUCT CODE	DESCRIPTION
WSET10250BL	1 x 2.5m EDGE tower kit in 2 transport cases
WSETFAB10250	1 x 2.5m EDGE tower printed fabric graphics
WSLKLBL1025I80BL	0.86 x 2.5m BrightWall 80 lightblocker panel
WSET15250BL	1.5 x 2.5m EDGE tower kit in 2 transport cases
WSETFAB15250	1.5 x 2.5m EDGE tower printed fabric graphics
WSLKLBL1525I80BL	1.36 x 2.5m BrightWall 80 lightblocker panel
WSET20250BL	2 x 2.5m EDGE tower kit in 2 transport cases
WSETFAB20250	2 x 2.5m EDGE tower printed fabric graphics
WSLKLBL2025I80BL	1.86 x 2.5m BrightWall 80 lightblocker panel

3m High

PRODUCT CODE	DESCRIPTION
WSET10300BL	1 x 3m EDGE tower kit in 2 transport cases
WSETFAB10300	1 x 3m EDGE tower printed fabric graphics
WSLKLBL1030I80BL	0.86 x 3m BrightWall 80 lightblocker panel
WSET15300BL	1.5 x 3m EDGE tower kit in 2 transport cases
WSETFAB15300	1.5 x 3m EDGE tower printed fabric graphics
WSLKLBL15I80BL	1.36 x 3m BrightWall 80 lightblocker panel
WSET20300BL	2 x 3m EDGE tower kit in 2 transport cases
WSETFAB20300	2 x 3m EDGE tower printed fabric graphics
WSLKLBL2030I80BL	1.86 x 3m BrightWall 80 lightblocker panel

STORAGE



Designed to keep your most valuable equipment safe EDGE lockable storage areas feature large format dye sub printed graphics on every surface - even the door!



VISION PANEL

Add a vision panel to your door by selecting the code below.

PRODUCT CODE

DESCRIPTION

KBED8620VP

Vision Panel for EDGE door -
610mm x 115mm viewing size

STORAGE

EDGE storage areas are available in 2 standard depths 1m & 1.5m.



1m Deep

Simple space saving storage

Our 1m EDGE storage areas are ideal when space is tight! The thinner design of our 1m deep storage areas makes them a perfect choice for most exhibitor needs.

Our external triangle connector joins the front wall to the door providing a neat finish to the corner. As standard these are finished anodised (silver), however you can upgrade to a sleeker, powder coated finish (white/black) using the code below.

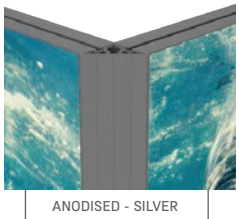

FROM  TO



OR



UPGRADE

PRODUCT CODE	KBEUPPCTRI77
DESCRIPTION	Upgrade to Powder Coated Triangular Extrusion (per corner)



1.5m Deep

Uninterrupted graphics

For graphic lovers!
Our 1.5m deep storage areas are more than just a storage area, they are a key part of your exhibition design. Using our external 'Y' connectors, graphics wrap around the corner providing an uninterrupted view of your companies message.

STORAGE

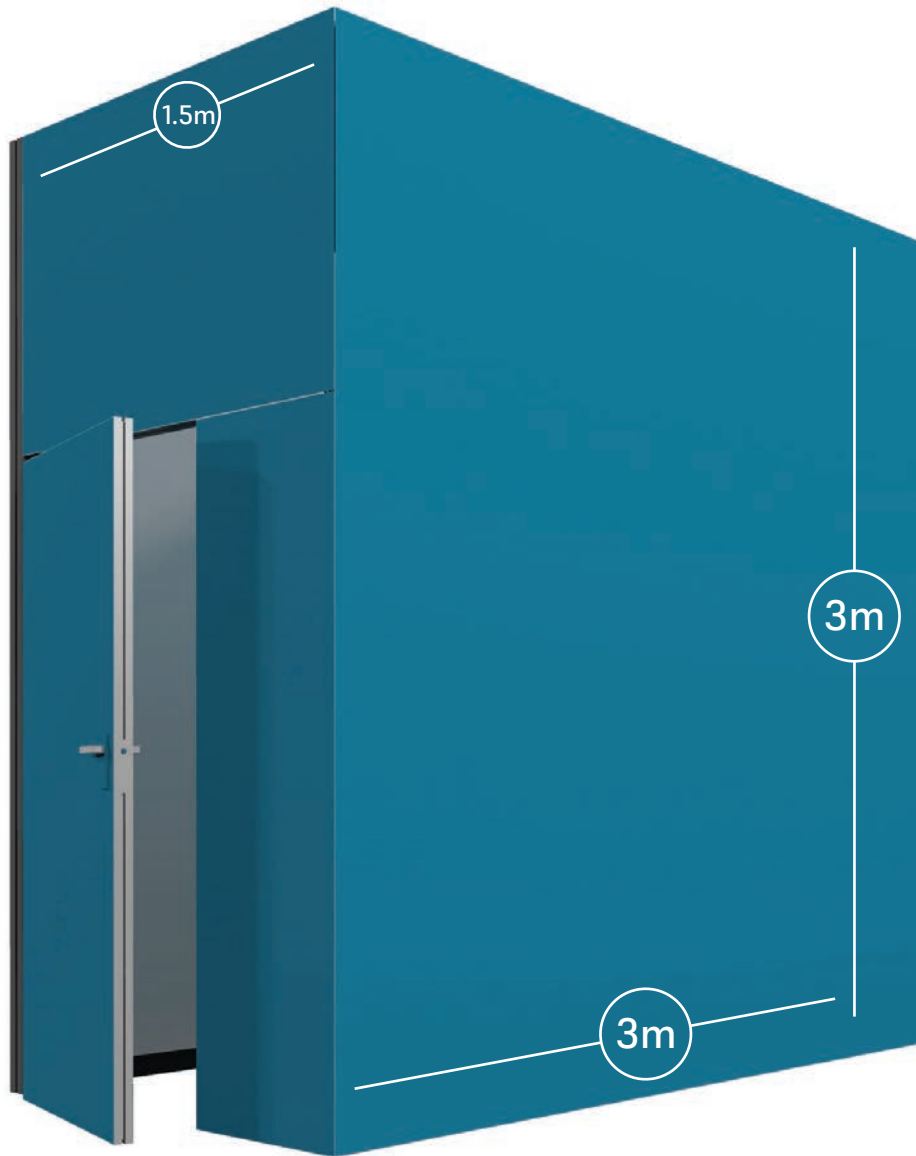

THE ULTIMATE IN RECONFIGURABILITY

Our EDGE storage areas offer the ultimate in scalability and reconfigurability. All storage areas are designed to reconfigure in height, width and depth.

Purchase our largest storage area above (3m x 1.5m x 3m) and watch as it reconfigures to suit all your future exhibit needs. Your storage area can scale from a show stopping display at 3m x 1.5m x 3m down to a simple space saving storage of 1m x 1m x 2.36m.

STORAGE

W - 1m
D - 1.5m
H - 3m



W - 2m
D - 1.5m
H - 2.36m



W - 2m
D - 1m
H - 3m



W - 2m
D - 1m
H - 2.36m



W - 1m
D - 1m
H - 2.36m



....AND MANY MORE

STORAGE - (2 SIDES VISIBLE)



Build your storage area in a corner booth and connect 2 of our corner display walls to create a unique and practical booth. Our 2 sides visible storage areas feature graphics on 2 walls (door and front). The rear 2 sides of the storage are closed with white fabric as standard.

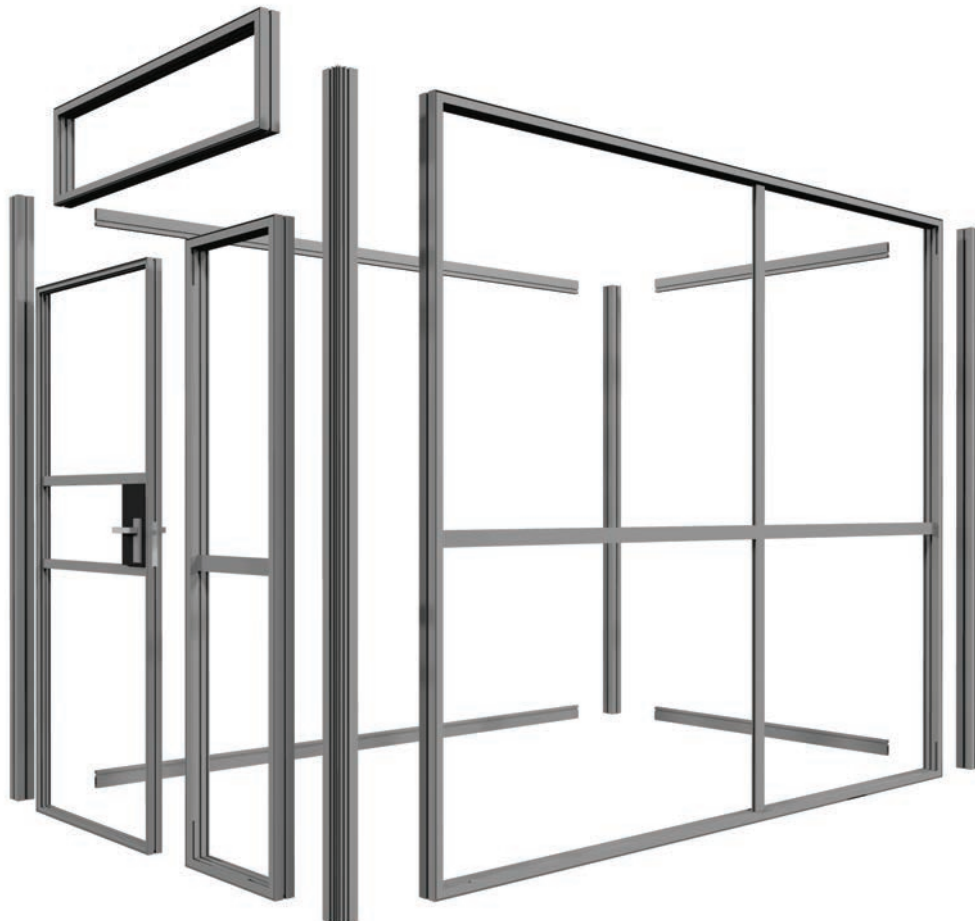

STORAGE - (2 SIDES VISIBLE - 2.36M HIGH)

1m Deep



W 1m x D 1m x H 2.36m

	PRODUCT CODE	DESCRIPTION
Hardware Printed Fabric	WSES1010236X2	1 x 1 x 2.36m EDGE 2 side storage kit
	WSES10102362F	1 x 1 x 2.36m EDGE 2 side storage fabric graphics

Product when assembled : W 1000mm x H 2360mm x D 1000mm

Transport Case : Small Poly Case, Large Poly Case & XL Poly Case

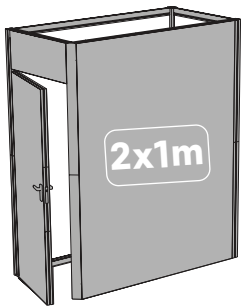

W 2m x D 1m x H 2.36m

	PRODUCT CODE	DESCRIPTION
Hardware Printed Fabric	WSES1020236X2	2 x 1 x 2.36m EDGE 2 side storage kit
	WSES10202362F	2 x 1 x 2.36m EDGE 2 side storage fabric graphics

Product when assembled : W 2000mm x H 2360mm x D 1000mm

Transport Case : 2 x Large Poly Case & XL Poly Case

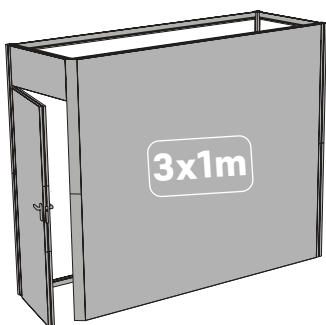

W 3m x D 1m x H 2.36m

	PRODUCT CODE	DESCRIPTION
Hardware Printed Fabric	WSES1030236X2	3 x 1 x 2.36m EDGE 2 side storage kit
	WSES10302362F	3 x 1 x 2.36m EDGE 2 side storage fabric graphics

Product when assembled : W 3000mm x H 2360mm x D 1000mm

Transport Case : 2 x Large Poly Case & XL Poly Case

*Custom sizes are available on request.

STORAGE - (2 SIDES VISIBLE - 2.36M HIGH)

1.5m Deep

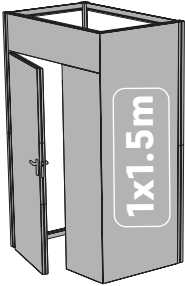

W 1m x D 1.5m x H 2.36m

	PRODUCT CODE	DESCRIPTION
Hardware Printed Fabric	WSES1510236X2	1 x 1.5 x 2.36m EDGE 2 side storage kit
	WSES15102362F	1 x 1.5 x 2.36m EDGE 2 side storage fabric graphics

Product when assembled : W 1000mm x H 2360mm x D 1500mm

Transport Case : Small Poly Case, Large Poly Case & XL Poly Case

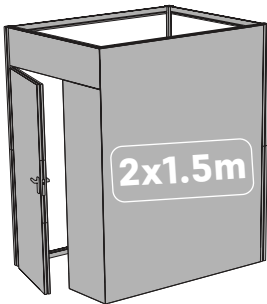

W 2m x D 1.5m x H 2.36m

	PRODUCT CODE	DESCRIPTION
Hardware Printed Fabric	WSES1520236X2	2 x 1.5 x 2.36m EDGE 2 side storage kit
	WSES15202362F	2 x 1.5 x 2.36m EDGE 2 side storage fabric graphics

Product when assembled : W 2000mm x H 2360mm x D 1500mm

Transport Case : 2 x Large Poly Case & XL Poly Case

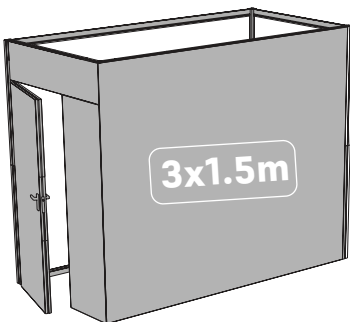

W 3m x D 1.5m x H 2.36m

	PRODUCT CODE	DESCRIPTION
Hardware Printed Fabric	WSES1530236X2	3 x 1.5 x 2.36m EDGE 2 side storage kit
	WSES15302362F	3 x 1.5 x 2.36m EDGE 2 side storage fabric graphics

Product when assembled : W 3000mm x H 2360mm x D 1500mm

Transport Case : 2 x Large Poly Case & XL Poly Case

STORAGE - (2 SIDES VISIBLE - 2.5M HIGH)

1m Deep



W 1m x D 1m x H 2.5m

	PRODUCT CODE	DESCRIPTION
Hardware Printed Fabric	WSES1010250X2	1 x 1 x 2.5m EDGE 2 side storage kit
	WSES10102502F	1 x 1 x 2.5m EDGE 2 side storage fabric graphics

Product when assembled : W 1000mm x H 2500mm x D 1000mm

Transport Case : Small Poly Case, Large Poly Case & XL Poly Case

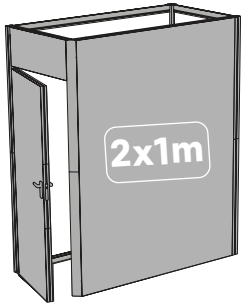

W 2m x D 1m x H 2.5m

	PRODUCT CODE	DESCRIPTION
Hardware Printed Fabric	WSES1020250X2	2 x 1 x 2.5m EDGE 2 side storage kit
	WSES10202502F	2 x 1 x 2.5m EDGE 2 side storage fabric graphics

Product when assembled : W 2000mm x H 2500mm x D 1000mm

Transport Case : 2 x Large Poly Case & XL Poly Case

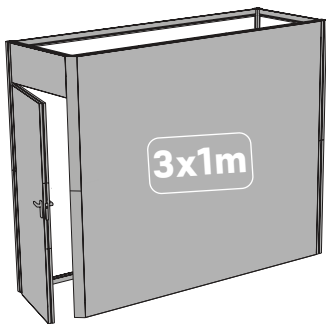

W 3m x D 1m x H 2.5m

	PRODUCT CODE	DESCRIPTION
Hardware Printed Fabric	WSES1030250X2	3 x 1 x 2.5m EDGE 2 side storage kit
	WSES10302502F	3 x 1 x 2.5m EDGE 2 side storage fabric graphics

Product when assembled : W 3000mm x H 2500mm x D 1000mm

Transport Case : 2 x Large Poly Case & XL Poly Case

*Custom sizes are available on request.

STORAGE - (2 SIDES VISIBLE - 2.5M HIGH)

1.5m Deep

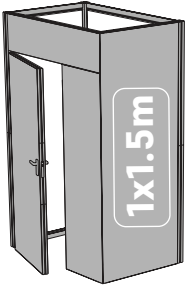

W 1m x D 1.5m x H 2.5m

	PRODUCT CODE	DESCRIPTION
Hardware Printed Fabric	WSES1510250X2	1 x 1.5 x 2.5m EDGE 2 side storage kit
	WSES15102502F	1 x 1.5 x 2.5m EDGE 2 side storage fabric graphics

Product when assembled : W 1000mm x H 2500mm x D 1500mm

Transport Case : Small Poly Case, Large Poly Case & XL Poly Case

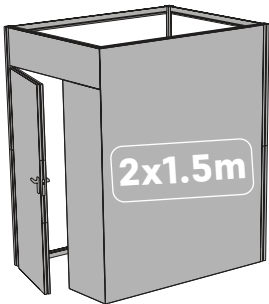

W 2m x D 1.5m x H 2.5m

	PRODUCT CODE	DESCRIPTION
Hardware Printed Fabric	WSES1520250X2	2 x 1.5 x 2.5m EDGE 2 side storage kit
	WSES15202502F	2 x 1.5 x 2.5m EDGE 2 side storage fabric graphics

Product when assembled : W 2000mm x H 2500mm x D 1500mm

Transport Case : 2 x Large Poly Case & XL Poly Case

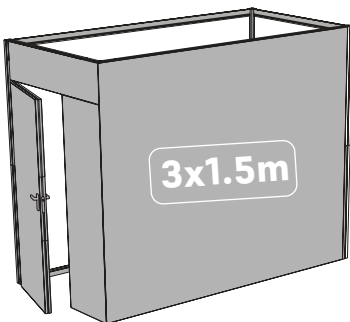

W 3m x D 1.5m x H 2.5m

	PRODUCT CODE	DESCRIPTION
Hardware Printed Fabric	WSES1530250X2	3 x 1.5 x 2.5m EDGE 2 side storage kit
	WSES15302502F	3 x 1.5 x 2.5m EDGE 2 side storage fabric graphics

Product when assembled : W 3000mm x H 2500mm x D 1500mm

Transport Case : 2 x Large Poly Case & XL Poly Case

STORAGE - (2 SIDES VISIBLE - 3M HIGH)

1m Deep



W 1m x D 1m x H 3m

	PRODUCT CODE	DESCRIPTION
Hardware Printed Fabric	WSES1010300X2	1 x 1 x 3m EDGE 2 side storage kit
	WSES10103002F	1 x 1 x 3m EDGE 2 side storage fabric graphics

Product when assembled : W 1000mm x H 3000mm x D 1000mm

Transport Case : Small Poly Case, Large Poly Case & XL Poly Case

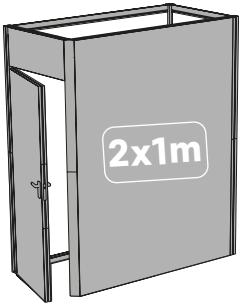

W 2m x D 1m x H 3m

	PRODUCT CODE	DESCRIPTION
Hardware Printed Fabric	WSES1020300X2	2 x 1 x 3m EDGE 2 side storage kit
	WSES10203002F	2 x 1 x 3m EDGE 2 side storage fabric graphics

Product when assembled : W 2000mm x H 3000mm x D 1000mm

Transport Case : 2 x Large Poly Case & XL Poly Case

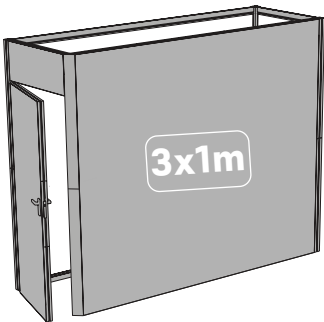

W 3m x D 1m x H 3m

	PRODUCT CODE	DESCRIPTION
Hardware Printed Fabric	WSES1030300X2	3 x 1 x 3m EDGE 2 side storage kit
	WSES10303002F	3 x 1 x 3m EDGE 2 side storage fabric graphics

Product when assembled : W 3000mm x H 3000mm x D 1000mm

Transport Case : 2 x Large Poly Case & XL Poly Case

*Custom sizes are available on request.

STORAGE - (2 SIDES VISIBLE - 3M HIGH)

1.5m Deep

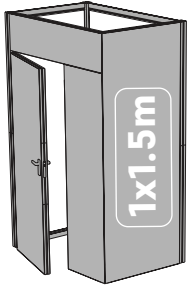

W 1m x D 1.5m x H 3m

	PRODUCT CODE	DESCRIPTION
Hardware Printed Fabric	WSES1510300X2	1 x 1.5 x 3m EDGE 2 side storage kit
	WSES15103002F	1 x 1.5 x 3m EDGE 2 side storage fabric graphics

Product when assembled : W 1000mm x H 3000mm x D 1500mm

Transport Case : Small Poly Case, Large Poly Case & XL Poly Case

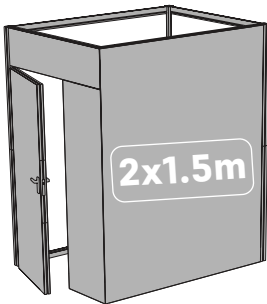

W 2m x D 1.5m x H 3m

	PRODUCT CODE	DESCRIPTION
Hardware Printed Fabric	WSES1520300X2	2 x 1.5 x 3m EDGE 2 side storage kit
	WSES15203002F	2 x 1.5 x 3m EDGE 2 side storage fabric graphics

Product when assembled : W 2000mm x H 3000mm x D 1500mm

Transport Case : 2 x Large Poly Case & XL Poly Case

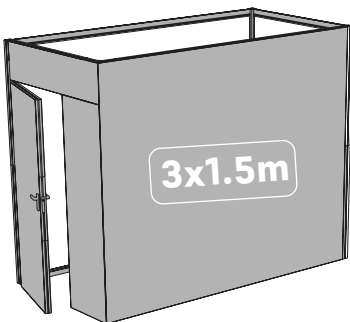

W 3m x D 1.5m x H 3m

	PRODUCT CODE	DESCRIPTION
Hardware Printed Fabric	WSES1530236X2	3 x 1.5 x 3m EDGE 2 side storage kit
	WSES15303002F	3 x 1.5 x 3m EDGE 2 side storage fabric graphics

Product when assembled : W 3000mm x H 3000mm x D 1500mm

Transport Case : 2 x Large Poly Case & XL Poly Case

STORAGE - (3 SIDES VISIBLE)



Build your storage area into a backwall using our 3 sides visible EDGE storage areas. With 180 degrees graphic viewing you are sure to get noticed at your next event. Our 3 sides visible storage areas feature graphics on 3 walls (door, front & side), the rear side of the storage is closed with white fabric as standard.

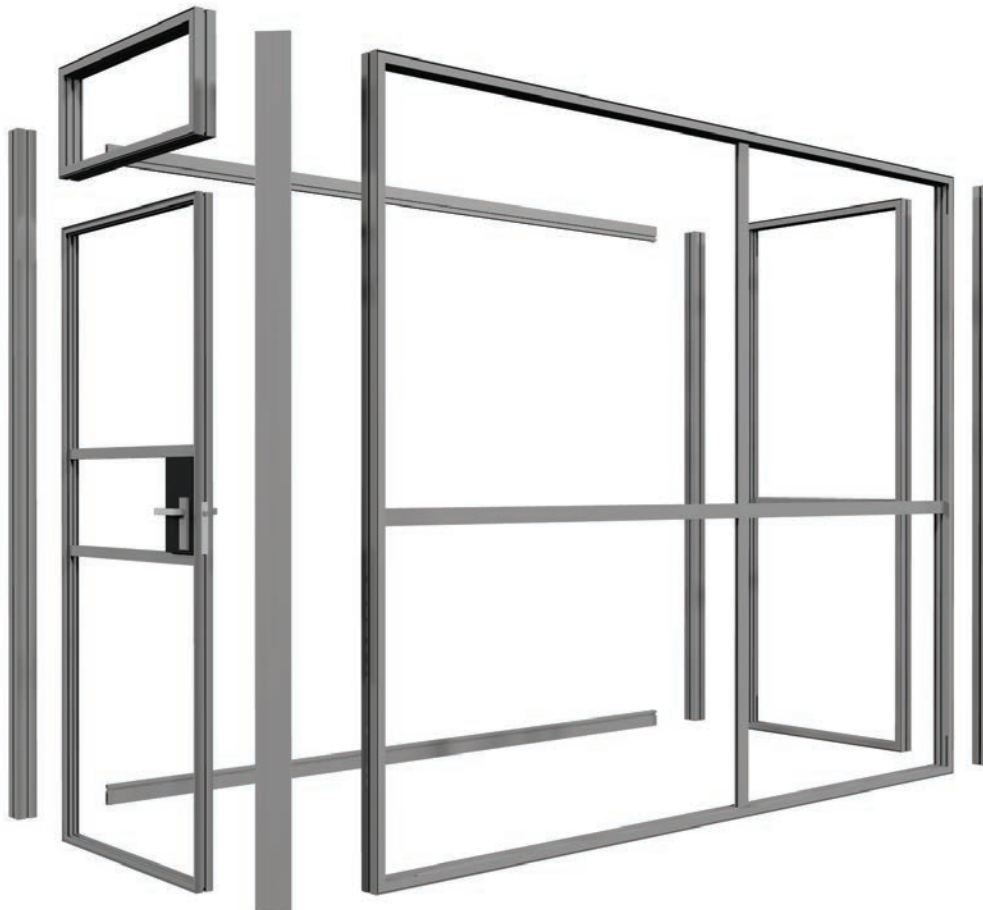

STORAGE - (3 SIDES VISIBLE - 2.36M HIGH)

1m Deep



W 1m x D 1m x H 2.36m

	PRODUCT CODE	DESCRIPTION
Hardware Printed Fabric	WSES1010236X3	1 x 1 x 2.36m EDGE 3 side storage kit
	WSES10102363F	1 x 1 x 2.36m EDGE 3 side storage fabric graphics

Product when assembled : W 1000mm x H 2360mm x D 1000mm

Transport Case : Small Poly Case, Large Poly Case & XL Poly Case

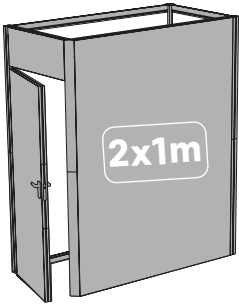

W 2m x D 1m x H 2.36m

	PRODUCT CODE	DESCRIPTION
Hardware Printed Fabric	WSES1020236X3	2 x 1 x 2.36m EDGE 3 side storage kit
	WSES10202363F	2 x 1 x 2.36m EDGE 3 side storage fabric graphics

Product when assembled : W 2000mm x H 2360mm x D 1000mm

Transport Case : 2 x Large Poly Case & XL Poly Case

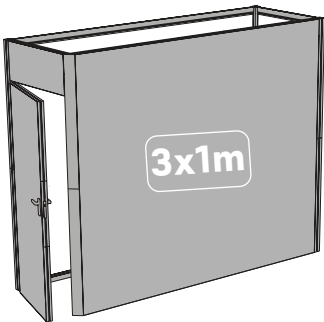

W 3m x D 1m x H 2.36m

	PRODUCT CODE	DESCRIPTION
Hardware Printed Fabric	WSES1030236X3	3 x 1 x 2.36m EDGE 3 side storage kit
	WSES10302363F	3 x 1 x 2.36m EDGE 3 side storage fabric graphics

Product when assembled : W 3000mm x H 2360mm x D 1000mm

Transport Case : 2 x Large Poly Case & XL Poly Case

STORAGE - (3 SIDES VISIBLE - 2.36M HIGH)

1.5m Deep



W 1m x D 1.5m x H 2.36m

	PRODUCT CODE	DESCRIPTION
Hardware Printed Fabric	WSES1510236X3	1 x 1.5 x 2.36m EDGE 3 side storage kit
	WSES15102363F	1 x 1.5 x 2.36m EDGE 3 side storage fabric graphics

Product when assembled : W 1000mm x H 2360mm x D 1500mm

Transport Case : Small Poly Case, Large Poly Case & XL Poly Case

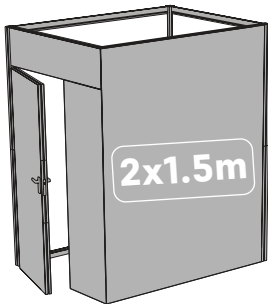

W 2m x D 1.5m x H 2.36m

	PRODUCT CODE	DESCRIPTION
Hardware Printed Fabric	WSES1520236X3	2 x 1.5 x 2.36m EDGE 3 side storage kit
	WSES15202363F	2 x 1.5 x 2.36m EDGE 3 side storage fabric graphics

Product when assembled : W 2000mm x H 2360mm x D 1500mm

Transport Case : 2 x Large Poly Case & XL Poly Case

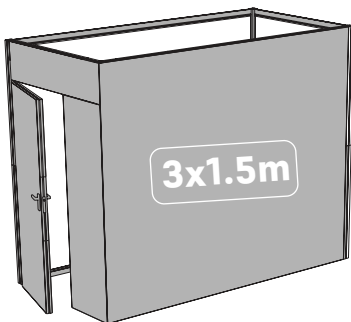

W 3m x D 1.5m x H 2.36m

	PRODUCT CODE	DESCRIPTION
Hardware Printed Fabric	WSES1530236X3	3 x 1.5 x 2.36m EDGE 3 side storage kit
	WSES15302363F	3 x 1.5 x 2.36m EDGE 3 side storage fabric graphics

Product when assembled : W 3000mm x H 2360mm x D 1500mm

Transport Case : 2 x Large Poly Case & XL Poly Case

*Custom sizes are available on request.

STORAGE - (3 SIDES VISIBLE - 2.5M HIGH)

1m Deep



W 1m x D 1m x H 2.5m

	PRODUCT CODE	DESCRIPTION
Hardware Printed Fabric	WSES1010250X3	1 x 1 x 2.5m EDGE 3 side storage kit
	WSES10102503F	1 x 1 x 2.5m EDGE 3 side storage fabric graphics

Product when assembled : W 1000mm x H 2500mm x D 1000mm

Transport Case : Small Poly Case, Large Poly Case & XL Poly Case

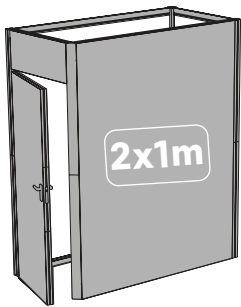

W 2m x D 1m x H 2.5m

	PRODUCT CODE	DESCRIPTION
Hardware Printed Fabric	WSES1020250X3	2 x 1 x 2.5m EDGE 3 side storage kit
	WSES10202503F	2 x 1 x 2.5m EDGE 3 side storage fabric graphics

Product when assembled : W 2000mm x H 2500mm x D 1000mm

Transport Case : 2 x Large Poly Case & XL Poly Case

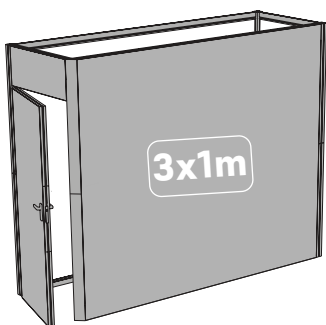

W 3m x D 1m x H 2.5m

	PRODUCT CODE	DESCRIPTION
Hardware Printed Fabric	WSES1030250X3	3 x 1 x 2.5m EDGE 3 side storage kit
	WSES10302503F	3 x 1 x 2.5m EDGE 3 side storage fabric graphics

Product when assembled : W 3000mm x H 2500mm x D 1000mm

Transport Case : 2 x Large Poly Case & XL Poly Case

STORAGE - (3 SIDES VISIBLE - 2.5M HIGH)

1.5m Deep



W 1m x D 1.5m x H 2.5m

	PRODUCT CODE	DESCRIPTION
Hardware Printed Fabric	WSES1510250X3	1 x 1.5 x 2.5m EDGE 3 side storage kit
	WSES15102503F	1 x 1.5 x 2.5m EDGE 3 side storage fabric graphics

Product when assembled : W 1000mm x H 2500mm x D 1500mm

Transport Case : Small Poly Case, Large Poly Case & XL Poly Case

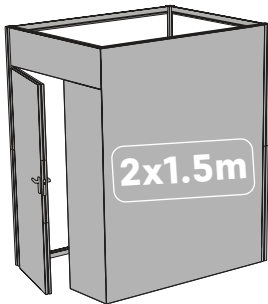

W 2m x D 1.5m x H 2.5m

	PRODUCT CODE	DESCRIPTION
Hardware Printed Fabric	WSES1520250X3	2 x 1.5 x 2.5m EDGE 3 side storage kit
	WSES15202503F	2 x 1.5 x 2.5m EDGE 3 side storage fabric graphics

Product when assembled : W 2000mm x H 2500mm x D 1500mm

Transport Case : 2 x Large Poly Case & XL Poly Case

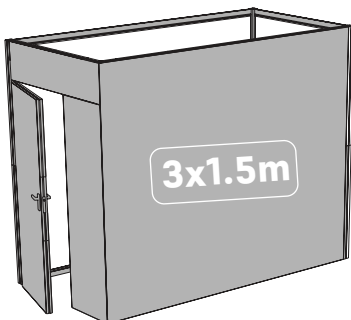

W 3m x D 1.5m x H 2.5m

	PRODUCT CODE	DESCRIPTION
Hardware Printed Fabric	WSES1530250X3	3 x 1.5 x 2.5m EDGE 3 side storage kit
	WSES15302503F	3 x 1.5 x 2.5m EDGE 3 side storage fabric graphics

Product when assembled : W 3000mm x H 2500mm x D 1500mm

Transport Case : 2 x Large Poly Case & XL Poly Case

*Custom sizes are available on request.

STORAGE - (3 SIDES VISIBLE - 3M HIGH)

1m Deep



W 1m x D 1m x H 3m

	PRODUCT CODE	DESCRIPTION
Hardware Printed Fabric	WSES1010300X3	1 x 1 x 3m EDGE 3 side storage kit
	WSES10103003F	1 x 1 x 3m EDGE 3 side storage fabric graphics

Product when assembled : W 1000mm x H 3000mm x D 1000mm

Transport Case : Small Poly Case, Large Poly Case & XL Poly Case

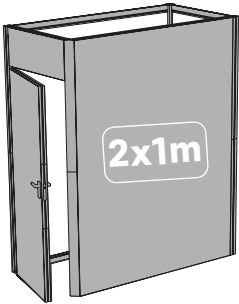

W 2m x D 1m x H 3m

	PRODUCT CODE	DESCRIPTION
Hardware Printed Fabric	WSES1020300X3	2 x 1 x 3m EDGE 3 side storage kit
	WSES10203003F	2 x 1 x 3m EDGE 3 side storage fabric graphics

Product when assembled : W 2000mm x H 3000mm x D 1000mm

Transport Case : 2 x Large Poly Case & XL Poly Case

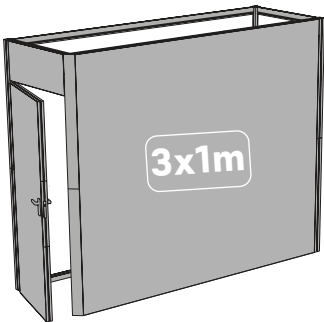

W 3m x D 1m x H 3m

	PRODUCT CODE	DESCRIPTION
Hardware Printed Fabric	WSES1030300X3	3 x 1 x 3m EDGE 3 side storage kit
	WSES10303003F	3 x 1 x 3m EDGE 2 side storage fabric graphics

Product when assembled : W 3000mm x H 3000mm x D 1000mm

Transport Case : 2 x Large Poly Case & XL Poly Case

STORAGE - (3 SIDES VISIBLE - 3M HIGH)

1.5m Deep



W 1m x D 1.5m x H 3m

	PRODUCT CODE	DESCRIPTION
Hardware Printed Fabric	WSES1510300X3	1 x 1.5 x 3m EDGE 3 side storage kit
	WSES15103003F	1 x 1.5 x 3m EDGE 3 side storage fabric graphics

Product when assembled : W 1000mm x H 3000mm x D 1500mm

Transport Case : Small Poly Case, Large Poly Case & XL Poly Case

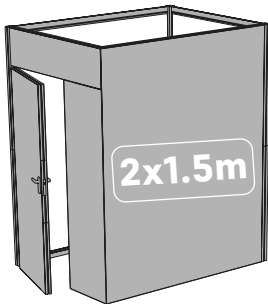

W 2m x D 1.5m x H 3m

	PRODUCT CODE	DESCRIPTION
Hardware Printed Fabric	WSES1520300X3	2 x 1.5 x 3m EDGE 3 side storage kit
	WSES15203003F	2 x 1.5 x 3m EDGE 3 side storage fabric graphics

Product when assembled : W 2000mm x H 3000mm x D 1500mm

Transport Case : 2 x Large Poly Case & XL Poly Case

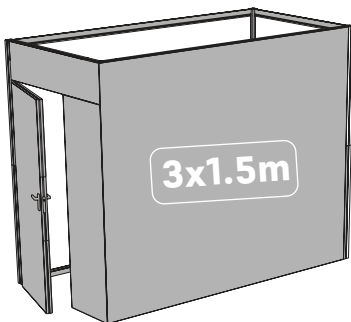

W 3m x D 1.5m x H 3m

	PRODUCT CODE	DESCRIPTION
Hardware Printed Fabric	WSES1530300X3	3 x 1.5 x 3m EDGE 3 side storage kit
	WSES15303003F	3 x 1.5 x 3m EDGE 3 side storage fabric graphics

Product when assembled : W 3000mm x H 3000mm x D 1500mm

Transport Case : 2 x Large Poly Case & XL Poly Case

*Custom sizes are available on request.

BACKLIT STORAGE - (2 SIDES VISIBLE)

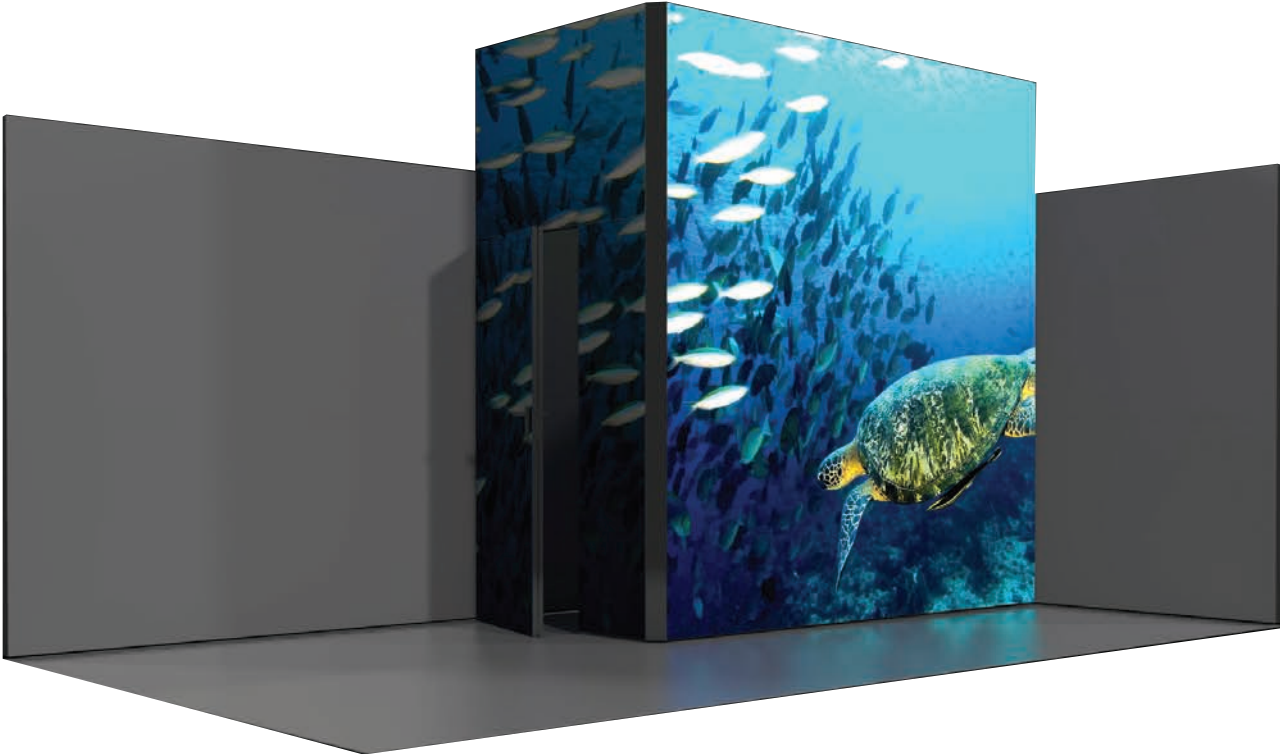

Stand out from the crowd by purchasing a backlit storage area. Combine the versatility and functionality of our storage areas with the impact of our BrightWall 80 backlit displays. Our backlit storage areas are the perfect display solution for you!

UPGRADE

Our backlit EDGE storage features 2 external triangle connectors on the front of the tower. As standard these are finished anodised (silver), however you can upgrade to a sleeker powder coated finish (white/black) using the code below.

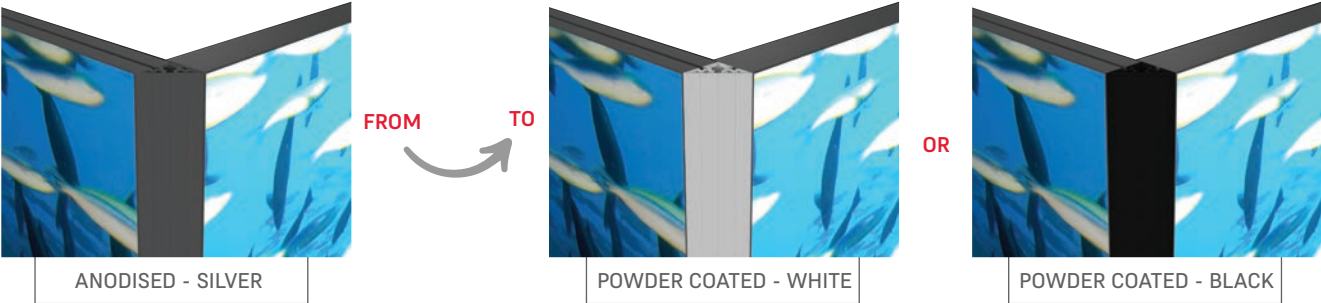

PRODUCT CODE	DESCRIPTION
KBEUPPCTRI77	Upgrade to Powder Coated Triangular Extrusion (per corner)

*1 powder coated upgrade kit required per 2 sided backlit storage.

BACKLIT STORAGE - (2 SIDES VISIBLE - 2.36M HIGH)

1m Deep

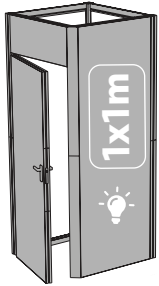

W 1m x D 1m x H 2.36m

	PRODUCT CODE	DESCRIPTION
Hardware	WSES1010236X2BL	1 x 1 x 2.36m EDGE 2 side backlit storage kit
Printed Fabric	WSES10102362BLF	1 x 1 x 2.36m EDGE 2 side backlit storage fabric graphics
Lightblocker	WSLKLBL10180BL	0.86 x 2.36m BrightWall 80 lightblocker panel

Product when assembled : W 1000mm x H 2360mm x D 1000mm

Transport Case : Small Poly Case, Large Poly Case & XL Poly Case

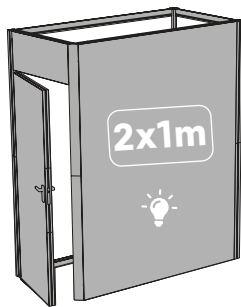

W 2m x D 1m x H 2.36m

	PRODUCT CODE	DESCRIPTION
Hardware	WSES1020236X2BL	2 x 1 x 2.36m EDGE 2 side backlit storage kit
Printed Fabric	WSES10202362BLF	2 x 1 x 2.36m EDGE 2 side backlit storage fabric graphics
Lightblocker	WSLKLBL20180BL	1.86 x 2.36m BrightWall 80 lightblocker panel

Product when assembled : W 2000mm x H 2360mm x D 1000mm

Transport Case : 2 x Large Poly Case & XL Poly Case

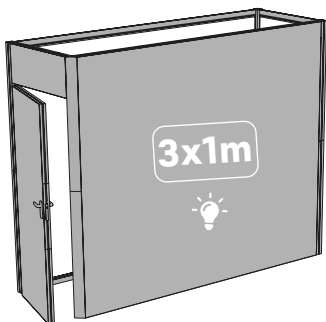

W 3m x D 1m x H 2.36m

	PRODUCT CODE	DESCRIPTION
Hardware	WSES1030236X2BL	3 x 1 x 2.36m EDGE 2 side backlit storage kit
Printed Fabric	WSES10302362BLF	3 x 1 x 2.36m EDGE 2 side backlit storage fabric graphics
Lightblocker	WSLKLBL30180BL	2.86 x 2.36m BrightWall 80 lightblocker panel

Product when assembled : W 3000mm x H 2360mm x D 1000mm

Transport Case : 2 x Large Poly Case & XL Poly Case

*Custom sizes are available on request.

BACKLIT STORAGE - (2 SIDES VISIBLE - 2.36M HIGH)

1.5m Deep

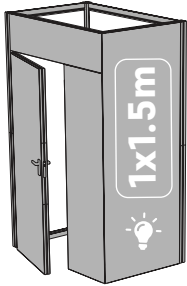

W 1m x D 1.5m x H 2.36m

	PRODUCT CODE	DESCRIPTION
Hardware	WSES1510236X2BL	1 x 1.5 x 2.36m EDGE 2 side backlit storage kit
Printed Fabric	WSES15102362BLF	1 x 1.5 x 2.36m EDGE 2 side backlit storage fabric graphics
Lightblocker	WSLKLBL10180BL	0.86 x 2.36m BrightWall 80 lightblocker panel

Product when assembled : W 1000mm x H 2360mm x D 1500mm

Transport Case : Small Poly Case, Large Poly Case & XL Poly Case

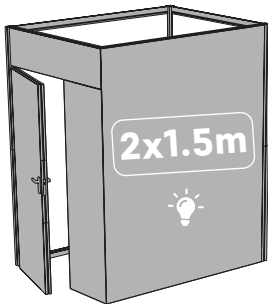

W 2m x D 1.5m x H 2.36m

	PRODUCT CODE	DESCRIPTION
Hardware	WSES1520236X2BL	2 x 1.5 x 2.36m EDGE 2 side backlit storage kit
Printed Fabric	WSES15202362BLF	2 x 1.5 x 2.36m EDGE 2 side backlit storage fabric graphics
Lightblocker	WSLKLBL20180BL	1.86 x 2.36m BrightWall 80 lightblocker panel

Product when assembled : W 2000mm x H 2360mm x D 1500mm

Transport Case : 2 x Large Poly Case & XL Poly Case

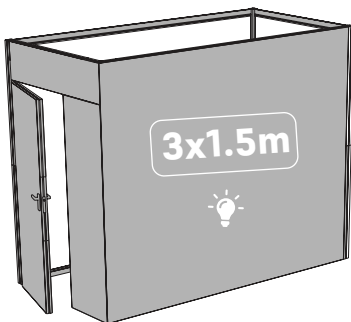

W 3m x D 1.5m x H 2.36m

	PRODUCT CODE	DESCRIPTION
Hardware	WSES1530236X2BL	3 x 1.5 x 2.36m EDGE 2 side backlit storage kit
Printed Fabric	WSES15302362BLF	3 x 1.5 x 2.36m EDGE 2 side backlit storage fabric graphics
Lightblocker	WSLKLBL30180BL	2.86 x 2.36m BrightWall 80 lightblocker panel

Product when assembled : W 3000mm x H 2360mm x D 1500mm

Transport Case : 2 x Large Poly Case & XL Poly Case

BACKLIT STORAGE - (2 SIDES VISIBLE - 2.5M HIGH)

1m Deep

W 1m x D 1m x H 2.5m

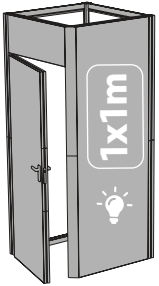

	PRODUCT CODE	DESCRIPTION
Hardware	WSES1010250X2BL	1 x 1 x 2.5m EDGE 2 side backlit storage kit
Printed Fabric	WSES10102502BLF	1 x 1 x 2.5m EDGE 2 side backlit storage fabric graphics
Lightblocker	WSLKLBL1025I80BL	0.86 x 2.5m BrightWall 80 lightblocker panel

Product when assembled : W 1000mm x H 2500mm x D 1000mm

Transport Case : Small Poly Case, Large Poly Case & XL Poly Case

W 2m x D 1m x H 2.5m

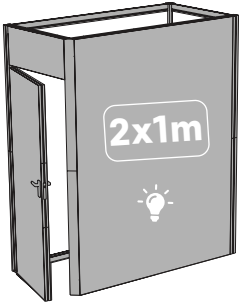

	PRODUCT CODE	DESCRIPTION
Hardware	WSES1020250X2BL	2 x 1 x 2.5m EDGE 2 side backlit storage kit
Printed Fabric	WSES10202502BLF	2 x 1 x 2.5m EDGE 2 side backlit storage fabric graphics
Lightblocker	WSLKLBL2025I80BL	1.86 x 2.5m BrightWall 80 lightblocker panel

Product when assembled : W 2000mm x H 2500mm x D 1000mm

Transport Case : 2 x Large Poly Case & XL Poly Case

W 3m x D 1m x H 2.5m

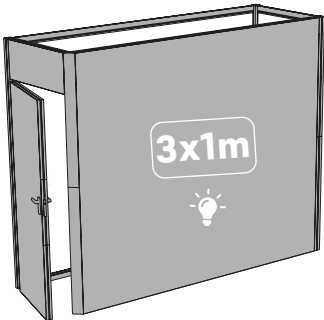

	PRODUCT CODE	DESCRIPTION
Hardware	WSES1030250X2BL	3 x 1 x 2.5m EDGE 2 side backlit storage kit
Printed Fabric	WSES10302502BLF	3 x 1 x 2.5m EDGE 2 side backlit storage fabric graphics
Lightblocker	WSLKLBL3025I80BL	2.86 x 2.5m BrightWall 80 lightblocker panel

Product when assembled : W 3000mm x H 2500mm x D 1000mm

Transport Case : 2 x Large Poly Case & XL Poly Case

*Custom sizes are available on request.

BACKLIT STORAGE - (2 SIDES VISIBLE - 2.5M HIGH)

1.5m Deep

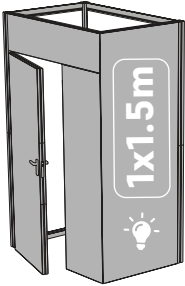

W 1m x D 1.5m x H 2.5m

	PRODUCT CODE	DESCRIPTION
Hardware	WSES1510250X2BL	1 x 1.5 x 2.5m EDGE 2 side backlit storage kit
Printed Fabric	WSES15102502BLF	1 x 1.5 x 2.5m EDGE 2 side backlit storage fabric graphics
Lightblocker	WSLKLBL1025I80BL	0.86 x 2.5m BrightWall 80 lightblocker panel

Product when assembled : W 1000mm x H 2500mm x D 1500mm

Transport Case : Small Poly Case, Large Poly Case & XL Poly Case

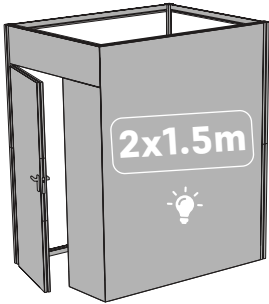

W 2m x D 1.5m x H 2.5m

	PRODUCT CODE	DESCRIPTION
Hardware	WSES1520250X2BL	2 x 1.5 x 2.5m EDGE 2 side backlit storage kit
Printed Fabric	WSES15202502BLF	2 x 1.5 x 2.5m EDGE 2 side backlit storage fabric graphics
Lightblocker	WSLKLBL2025I80BL	1.86 x 2.5m BrightWall 80 lightblocker panel

Product when assembled : W 2000mm x H 2500mm x D 1500mm

Transport Case : 2 x Large Poly Case & XL Poly Case

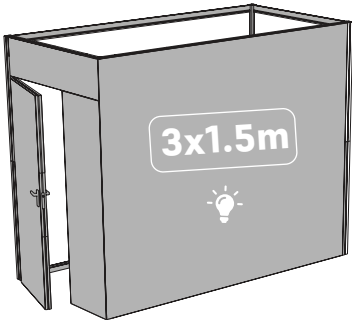

W 3m x D 1.5m x H 2.5m

	PRODUCT CODE	DESCRIPTION
Hardware	WSES1530250X2BL	3 x 1.5 x 2.5m EDGE 2 side backlit storage kit
Printed Fabric	WSES15302502BLF	3 x 1.5 x 2.5m EDGE 2 side backlit storage fabric graphics
Lightblocker	WSLKLBL3025I80BL	2.86 x 2.5m BrightWall 80 lightblocker panel

Product when assembled : W 3000mm x H 2500mm x D 1500mm

Transport Case : 2 x Large Poly Case & XL Poly Case

BACKLIT STORAGE - (2 SIDES VISIBLE - 3M HIGH)

1m Deep

W 1m x D 1m x H 3m

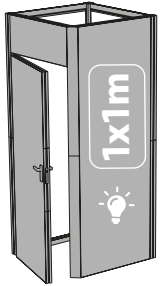

	PRODUCT CODE	DESCRIPTION
Hardware	WSES1010300X2BL	1 x 1 x 3m EDGE 2 side backlit storage kit
Printed Fabric	WSES10103002BLF	1 x 1 x 3m EDGE 2 side backlit storage fabric graphics
Lightblocker	WSLKLBL1030180BL	0.86 x 2.5m BrightWall 80 lightblocker panel

Product when assembled : W 1000mm x H 3000mm x D 1000mm

Transport Case : Small Poly Case, Large Poly Case & XL Poly Case

W 2m x D 1m x H 3m

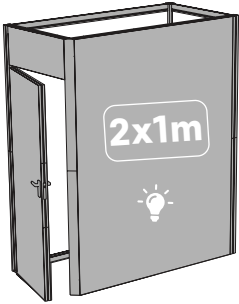

	PRODUCT CODE	DESCRIPTION
Hardware	WSES1020300X2BL	2 x 1 x 3m EDGE 2 side backlit storage kit
Printed Fabric	WSES10203002BLF	2 x 1 x 3m EDGE 2 side backlit storage fabric graphics
Lightblocker	WSLKLBL2030180BL	1.86 x 3m BrightWall 80 lightblocker panel

Product when assembled : W 2000mm x H 3000mm x D 1000mm

Transport Case : 2 x Large Poly Case & XL Poly Case

W 3m x D 1m x H 3m

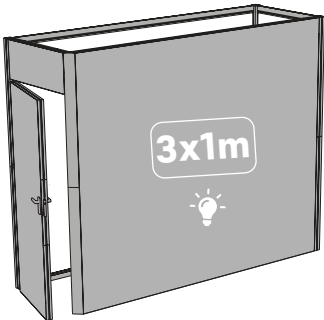

	PRODUCT CODE	DESCRIPTION
Hardware	WSES1030300X2BL	3 x 1 x 3m EDGE 2 side backlit storage kit
Printed Fabric	WSES10303002BLF	3 x 1 x 3m EDGE 2 side backlit storage fabric graphics
Lightblocker	WSLKLBL3030180BL	2.86 x 3m BrightWall 80 lightblocker panel

Product when assembled : W 3000mm x H 3000mm x D 1000mm

Transport Case : 2 x Large Poly Case & XL Poly Case

*Custom sizes are available on request.

BACKLIT STORAGE - (2 SIDES VISIBLE - 3M HIGH)

1.5m Deep

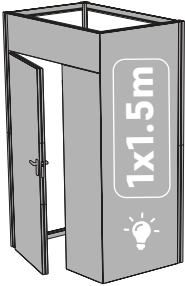

W 1m x D 1.5m x H 3m

	PRODUCT CODE	DESCRIPTION
Hardware	WSES1510300X2BL	1 x 1.5 x 3m EDGE 2 side backlit storage kit
Printed Fabric	WSES15103002BLF	1 x 1.5 x 3m EDGE 2 side backlit storage fabric graphics
Lightblocker	WSLKLBL1030I80BL	0.86 x 3m BrightWall 80 lightblocker panel

Product when assembled : W 1000mm x H 3000mm x D 1500mm

Transport Case : Small Poly Case, Large Poly Case & XL Poly Case

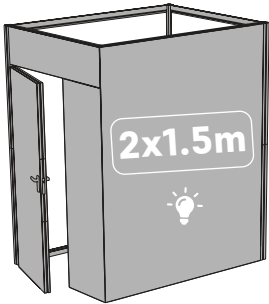

W 2m x D 1.5m x H 3m

	PRODUCT CODE	DESCRIPTION
Hardware	WSES1520300X2BL	2 x 1.5 x 3m EDGE 2 side backlit storage kit
Printed Fabric	WSES15203002BLF	2 x 1.5 x 3m EDGE 2 side backlit storage fabric graphics
Lightblocker	WSLKLBL2030I80BL	1.86 x 3m BrightWall 80 lightblocker panel

Product when assembled : W 2000mm x H 3000mm x D 1500mm

Transport Case : 2 x Large Poly Case & XL Poly Case

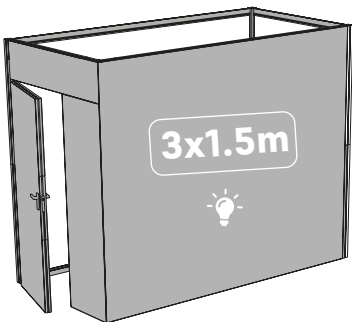

W 3m x D 1.5m x H 3m

	PRODUCT CODE	DESCRIPTION
Hardware	WSES1530300X2BL	3 x 1.5 x 3m EDGE 2 side backlit storage kit
Printed Fabric	WSES15303002BLF	3 x 1.5 x 3m EDGE 2 side backlit storage fabric graphics
Lightblocker	WSLKLBL3030I80BL	2.86 x 3m BrightWall 80 lightblocker panel

Product when assembled : W 3000mm x H 2500mm x D 1500mm

Transport Case : 2 x Large Poly Case & XL Poly Case

BACKLIT STORAGE - (3 SIDES VISIBLE)



Stand out from the crowd by purchasing a backlit storage area. Combine the versatility and functionality of our storage areas with the impact of our BrightWall 80 backlit displays. Our backlit storage areas are the perfect display solution for you!

UPGRADE

Our backlit EDGE storage features 2 external triangle connectors on the front of the tower. As standard these are finished anodised (silver), however you can upgrade to a sleeker powder coated finish (white/black) using the code below.

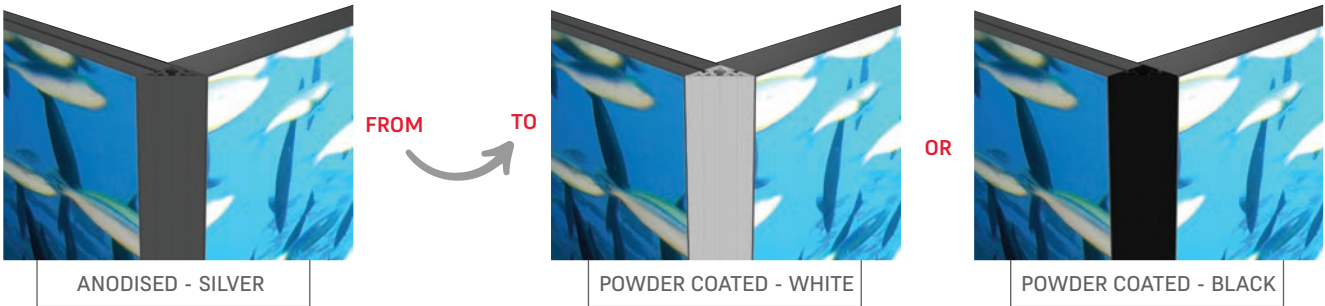

PRODUCT CODE	DESCRIPTION
KBEUPPCTRI77	Upgrade to Powder Coated Triangular Extrusion (per corner)

*1 powder coated upgrade kit required per 2 sided backlit storage.

BACKLIT STORAGE - (3 SIDES VISIBLE - 2.36M HIGH)

1m Deep

W 1m x D 1m x H 2.36m

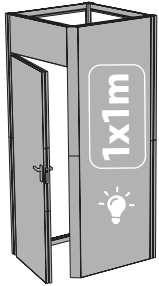

	PRODUCT CODE	DESCRIPTION
Hardware	WSES1010236X3BL	1 x 1 x 2.36m EDGE 3 side backlit storage kit
Printed Fabric	WSES10102363BLF	1 x 1 x 2.36m EDGE 3 side backlit storage fabric graphics
Lightblocker	WSLKLBL10180BL	0.86 x 2.36m BrightWall 80 lightblocker panel

Product when assembled : W 1000mm x H 2360mm x D 1000mm

Transport Case : Small Poly Case, Large Poly Case & XL Poly Case

W 2m x D 1m x H 2.36m

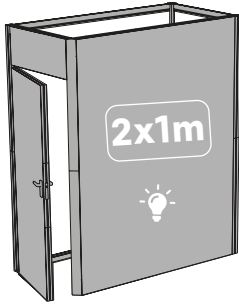

	PRODUCT CODE	DESCRIPTION
Hardware	WSES1020236X3BL	2 x 1 x 2.36m EDGE 3 side backlit storage kit
Printed Fabric	WSES10202363BLF	2 x 1 x 2.36m EDGE 3 side backlit storage fabric graphics
Lightblocker	WSLKLBL20180BL	1.86 x 2.36m BrightWall 80 lightblocker panel

Product when assembled : W 2000mm x H 2360mm x D 1000mm

Transport Case : 2 x Large Poly Case & XL Poly Case

W 3m x D 1m x H 2.36m

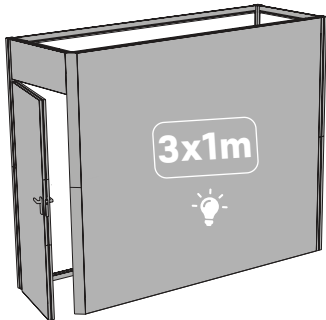

	PRODUCT CODE	DESCRIPTION
Hardware	WSES1030236X3BL	3 x 1 x 2.36m EDGE 3 side backlit storage kit
Printed Fabric	WSES10302363BLF	3 x 1 x 2.36m EDGE 3 side backlit storage fabric graphics
Lightblocker	WSLKLBL30180BL	2.86 x 2.36m BrightWall 80 lightblocker panel

Product when assembled : W 3000mm x H 2360mm x D 1000mm

Transport Case : 2 x Large Poly Case & XL Poly Case

*Each storage area includes - hardware, transport cases & white fabric for rear of storage & door.
*Custom sizes are available on request.

BACKLIT STORAGE - (3 SIDES VISIBLE - 2.36M HIGH)

1.5m Deep

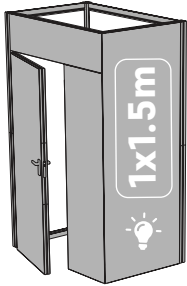

W 1m x D 1.5m x H 2.36m

	PRODUCT CODE	DESCRIPTION
Hardware	WSES1510236X3BL	1 x 1.5 x 2.36m EDGE 3 side backlit storage kit
Printed Fabric	WSES15102363BLF	1 x 1.5 x 2.36m EDGE 3 side backlit storage fabric graphics
Lightblocker	WSLKLBL10I80BL	0.86 x 2.36m BrightWall 80 lightblocker panel

Product when assembled : W 1000mm x H 2360mm x D 1500mm

Transport Case : Small Poly Case, Large Poly Case & XL Poly Case

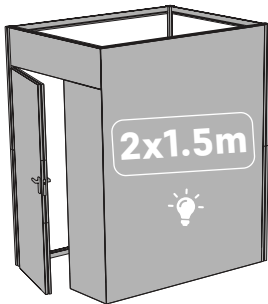

W 2m x D 1.5m x H 2.36m

	PRODUCT CODE	DESCRIPTION
Hardware	WSES1520236X3BL	2 x 1.5 x 2.36m EDGE 3 side backlit storage kit
Printed Fabric	WSES15202363BLF	2 x 1.5 x 2.36m EDGE 3 side backlit storage fabric graphics
Lightblocker	WSLKLBL20I80BL	1.86 x 2.36m BrightWall 80 lightblocker panel

Product when assembled : W 2000mm x H 2360mm x D 1500mm

Transport Case : 2 x Large Poly Case & XL Poly Case

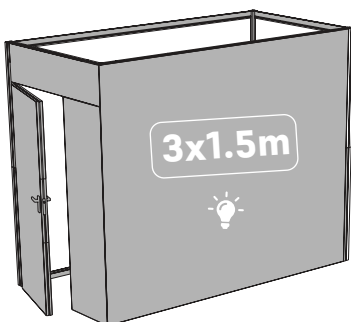

W 3m x D 1.5m x H 2.36m

	PRODUCT CODE	DESCRIPTION
Hardware	WSES1530236X3BL	3 x 1.5 x 2.36m EDGE 3 side backlit storage kit
Printed Fabric	WSES15302363BLF	3 x 1.5 x 2.36m EDGE 3 side backlit storage fabric graphics
Lightblocker	WSLKLBL30I80BL	2.86 x 2.36m BrightWall 80 lightblocker panel

Product when assembled : W 3000mm x H 2360mm x D 1500mm

Transport Case : 2 x Large Poly Case & XL Poly Case

*Each storage area includes - hardware, transport cases & white fabric for rear of storage & door.
*Custom sizes are available on request.

BACKLIT STORAGE - (3 SIDES VISIBLE - 2.5M HIGH)

1m Deep

W 1m x D 1m x H 2.5m

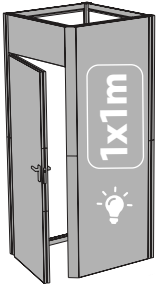

	PRODUCT CODE	DESCRIPTION
Hardware	WSES1010250X3BL	1 x 1 x 2.5m EDGE 3 side backlit storage kit
Printed Fabric	WSES10102503BLF	1 x 1 x 2.5m EDGE 3 side backlit storage fabric graphics
Lightblocker	WSLKLBL1025I80BL	0.86 x 2.5m BrightWall 80 lightblocker panel

Product when assembled : W 1000mm x H 2500mm x D 1000mm

Transport Case : Small Poly Case, Large Poly Case & XL Poly Case

W 2m x D 1m x H 2.5m

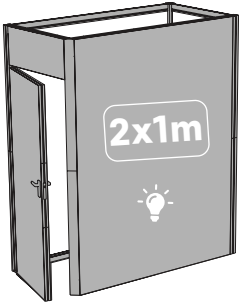

	PRODUCT CODE	DESCRIPTION
Hardware	WSES1020250X3BL	2 x 1 x 2.5m EDGE 3 side backlit storage kit
Printed Fabric	WSES10202503BLF	2 x 1 x 2.5m EDGE 3 side backlit storage fabric graphics
Lightblocker	WSLKLBL2025I80BL	1.86 x 2.5m BrightWall 80 lightblocker panel

Product when assembled : W 2000mm x H 2500mm x D 1000mm

Transport Case : 2 x Large Poly Case & XL Poly Case

W 3m x D 1m x H 2.5m

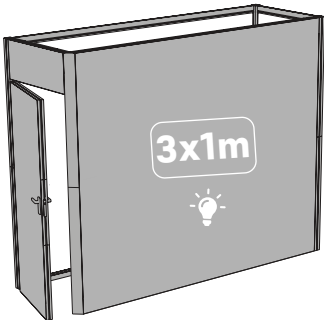

	PRODUCT CODE	DESCRIPTION
Hardware	WSES1030250X3BL	3 x 1 x 2.5m EDGE 3 side backlit storage kit
Printed Fabric	WSES10302503BLF	3 x 1 x 2.5m EDGE 3 side backlit storage fabric graphics
Lightblocker	WSLKLBL3025I80BL	2.86 x 2.5m BrightWall 80 lightblocker panel

Product when assembled : W 3000mm x H 2500mm x D 1000mm

Transport Case : 2 x Large Poly Case & XL Poly Case

*Each storage area includes - hardware, transport cases & white fabric for rear of storage & door.
*Custom sizes are available on request.

BACKLIT STORAGE - (3 SIDES VISIBLE - 2.5M HIGH)

1.5m Deep

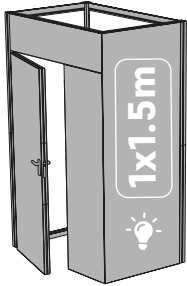

W 1m x D 1.5m x H 2.5m

	PRODUCT CODE	DESCRIPTION
Hardware	WSES1510250X3BL	1 x 1.5 x 2.5m EDGE 3 side backlit storage kit
Printed Fabric	WSES15102503BLF	1 x 1.5 x 2.5m EDGE 3 side backlit storage fabric graphics
Lightblocker	WSLKLBL1025I80BL	0.86 x 2.5m BrightWall 80 lightblocker panel

Product when assembled : W 1000mm x H 2500mm x D 1500mm

Transport Case : Small Poly Case, Large Poly Case & XL Poly Case

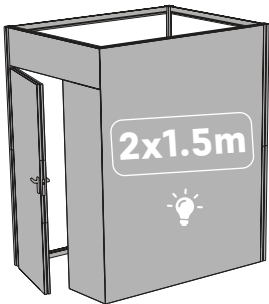

W 2m x D 1.5m x H 2.5m

	PRODUCT CODE	DESCRIPTION
Hardware	WSES1520250X3BL	2 x 1.5 x 2.5m EDGE 3 side backlit storage kit
Printed Fabric	WSES15202503BLF	2 x 1.5 x 2.5m EDGE 3 side backlit storage fabric graphics
Lightblocker	WSLKLBL2025I80BL	1.86 x 2.5m BrightWall 80 lightblocker panel

Product when assembled : W 2000mm x H 2500mm x D 1500mm

Transport Case : 2 x Large Poly Case & XL Poly Case

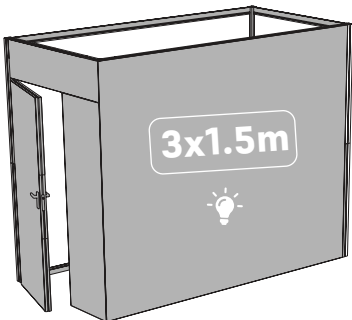

W 3m x D 1.5m x H 2.5m

	PRODUCT CODE	DESCRIPTION
Hardware	WSES1530250X3BL	3 x 1.5 x 2.5m EDGE 3 side backlit storage kit
Printed Fabric	WSES15302503BLF	3 x 1.5 x 2.5m EDGE 3 side backlit storage fabric graphics
Lightblocker	WSLKLBL3025I80BL	2.86 x 2.5m BrightWall 80 lightblocker panel

Product when assembled : W 3000mm x H 2500mm x D 1500mm

Transport Case : 2 x Large Poly Case & XL Poly Case

*Each storage area includes - hardware, transport cases & white fabric for rear of storage & door.
 *Custom sizes are available on request.

BACKLIT STORAGE - (3 SIDES VISIBLE - 3M HIGH)

1m Deep

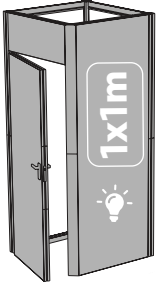

W 1m x D 1m x H 3m

	PRODUCT CODE	DESCRIPTION
Hardware	WSES1010300X3BL	1 x 1 x 3m EDGE 3 side backlit storage kit
Printed Fabric	WSES10103003BLF	1 x 1 x 3m EDGE 3 side backlit storage fabric graphics
Lightblocker	WSLKLBL1030180BL	0.86 x 2.5m BrightWall 80 lightblocker panel

Product when assembled : W 1000mm x H 3000mm x D 1000mm

Transport Case : Small Poly Case, Large Poly Case & XL Poly Case

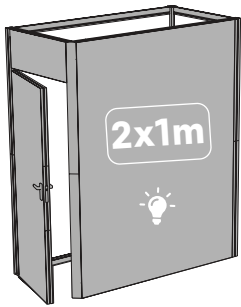

W 2m x D 1m x H 3m

	PRODUCT CODE	DESCRIPTION
Hardware	WSES1020300X3BL	2 x 1 x 3m EDGE 3 side backlit storage kit
Printed Fabric	WSES10203003BLF	2 x 1 x 3m EDGE 3 side backlit storage fabric graphics
Lightblocker	WSLKLBL2030180BL	1.86 x 3m BrightWall 80 lightblocker panel

Product when assembled : W 2000mm x H 3000mm x D 1000mm

Transport Case : 2 x Large Poly Case & XL Poly Case

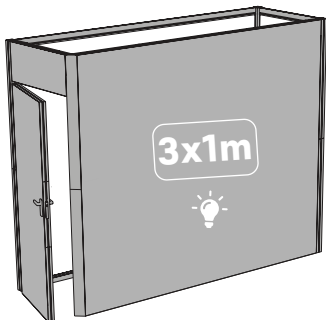

W 3m x D 1m x H 3m

	PRODUCT CODE	DESCRIPTION
Hardware	WSES1030300X3BL	3 x 1 x 3m EDGE 3 side backlit storage kit
Printed Fabric	WSES10303003BLF	3 x 1 x 3m EDGE 3 side backlit storage fabric graphics
Lightblocker	WSLKLBL3030180BL	2.86 x 3m BrightWall 80 lightblocker panel

Product when assembled : W 3000mm x H 3000mm x D 1000mm

Transport Case : 2 x Large Poly Case & XL Poly Case

STORAGE SUMMARY - (3 SIDES VISIBLE)

1.5m Deep

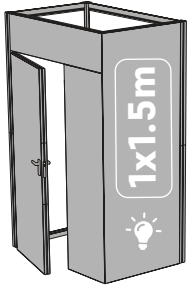

W 1m x D 1.5m x H 3m

	PRODUCT CODE	DESCRIPTION
Hardware	WSES1510300X3BL	1 x 1.5 x 3m EDGE 3 side backlit storage kit
Printed Fabric	WSES15103003BLF	1 x 1.5 x 3m EDGE 3 side backlit storage fabric graphics
Lightblocker	WSLKLBL1030I80BL	0.86 x 3m BrightWall 80 lightblocker panel

Product when assembled : W 1000mm x H 3000mm x D 1500mm

Transport Case : Small Poly Case, Large Poly Case & XL Poly Case

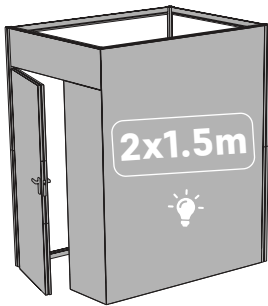

W 2m x D 1.5m x H 3m

	PRODUCT CODE	DESCRIPTION
Hardware	WSES1520300X3BL	2 x 1.5 x 3m EDGE 3 side backlit storage kit
Printed Fabric	WSES15203003BLF	2 x 1.5 x 3m EDGE 3 side backlit storage fabric graphics
Lightblocker	WSLKLBL2030I80BL	1.86 x 3m BrightWall 80 lightblocker panel

Product when assembled : W 2000mm x H 3000mm x D 1500mm

Transport Case : 2 x Large Poly Case & XL Poly Case

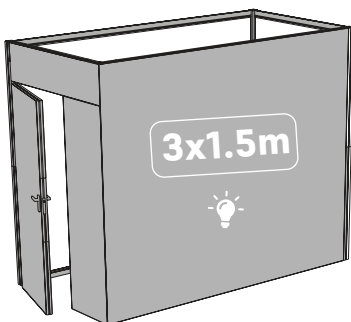

W 3m x D 1.5m x H 3m

	PRODUCT CODE	DESCRIPTION
Hardware	WSES1530300X3BL	3 x 1.5 x 3m EDGE 3 side backlit storage kit
Printed Fabric	WSES15303003BLF	3 x 1.5 x 3m EDGE 3 side backlit storage fabric graphics
Lightblocker	WSLKLBL3030I80BL	2.86 x 3m BrightWall 80 lightblocker panel

Product when assembled : W 3000mm x H 3000mm x D 1500mm

Transport Case : 2 x Large Poly Case & XL Poly Case

*Each storage area includes - hardware, transport cases & white fabric for rear of storage & door.
*Custom sizes are available on request.

STORAGE SUMMARY - (2 SIDES VISIBLE)

2.36m High

1m Deep

PRODUCT CODE	DESCRIPTION
WSES1010236X2	1 x 1 x 2.36m EDGE 2 sides storage kit
WSES10102362BLF	1 x 1 x 2.36m EDGE 2 sides storage fabric graphics
WSES1020236X2	2 x 1 x 2.36m EDGE 2 sides storage kit
WSES10202362BL	2 x 1 x 2.36m EDGE 2 sides storage fabric graphics
WSES1030236X2	3 x 1 x 2.36m EDGE 2 sides storage kit
WSES10302362BLF	3 x 1 x 2.36m EDGE 2 sides storage fabric graphics

1.5m Deep

WSES1510236X2	1 x 1.5 x 2.36m EDGE 2 sides storage kit
WSES15102362BLF	1 x 1.5 x 2.36m EDGE 2 sides storage fabric graphics
WSES1520236X2	2 x 1.5 x 2.36m EDGE 2 sides storage kit
WSES15202362BL	2 x 1.5 x 2.36m EDGE 2 sides storage fabric graphics
WSES1530236X2	3 x 1.5 x 2.36m EDGE 2 sides storage kit
WSES15302362BLF	3 x 1.5 x 2.36m EDGE 2 sides storage fabric graphics

2.5m High

1m Deep

PRODUCT CODE	DESCRIPTION
WSES1010250X2	1 x 1 x 2.5m EDGE 2 sides storage kit
WSES10102502BLF	1 x 1 x 2.5m EDGE 2 sides storage fabric graphics
WSES1020250X2	2 x 1 x 2.5m EDGE 2 sides storage kit
WSES10202502BL	2 x 1 x 2.5m EDGE 2 sides storage fabric graphics
WSES1030250X2	3 x 1 x 2.5m EDGE 2 sides storage kit
WSES10302502BLF	3 x 1 x 2.5m EDGE 2 sides storage fabric graphics

1.5m Deep

WSES1510250X2	1 x 1.5 x 2.5m EDGE 2 sides storage kit
WSES15102502BLF	1 x 1.5 x 2.5m EDGE 2 sides storage fabric graphics
WSES1520250X2	2 x 1.5 x 2.5m EDGE 2 sides storage kit
WSES15202502BL	2 x 1.5 x 2.5m EDGE 2 sides storage fabric graphics
WSES1530250X2	3 x 1.5 x 2.5m EDGE 2 sides storage kit
WSES15302502BLF	3 x 1.5 x 2.5m EDGE 2 sides storage fabric graphics

3m High

1m Deep

PRODUCT CODE	DESCRIPTION
WSES1010300X2	1 x 1 x 3m EDGE 2 sides storage kit
WSES10103002BLF	1 x 1 x 3m EDGE 2 sides storage fabric graphics
WSES1020300X2	2 x 1 x 3m EDGE 2 sides storage kit
WSES10203002BL	2 x 1 x 3m EDGE 2 sides storage fabric graphics
WSES1030300X2	3 x 1 x 3m EDGE 2 sides storage kit
WSES10303002BLF	3 x 1 x 3m EDGE 2 sides storage fabric graphics

1.5m Deep

WSES1510300X2	1 x 1.5 x 3m EDGE 2 sides storage kit
WSES15103002BLF	1 x 1.5 x 3m EDGE 2 sides storage fabric graphics
WSES1520300X2	2 x 1.5 x 3m EDGE 2 sides storage kit
WSES15203002BL	2 x 1.5 x 3m EDGE 2 sides storage fabric graphics
WSES1530300X2	3 x 1.5 x 3m EDGE 2 sides storage kit
WSES15303002BLF	3 x 1.5 x 3m EDGE 2 sides storage fabric graphics

STORAGE SUMMARY - (3 SIDES VISIBLE)

2.36m High

1m Deep

PRODUCT CODE	DESCRIPTION
WSES1010236X3	1 x 1 x 2.36m EDGE 3 sides storage kit
WSES10102363BLF	1 x 1 x 2.36m EDGE 3 sides storage fabric graphics
WSES1020236X3	2 x 1 x 2.36m EDGE 3 sides storage kit
WSES10202363BL	2 x 1 x 2.36m EDGE 3 sides storage fabric graphics
WSES1030236X3	3 x 1 x 2.36m EDGE 3 sides storage kit
WSES10302363BLF	3 x 1 x 2.36m EDGE 3 sides storage fabric graphics

1.5m Deep

WSES1510236X3	1 x 1.5 x 2.36m EDGE 3 sides storage kit
WSES15102363BLF	1 x 1.5 x 2.36m EDGE 3 sides storage fabric graphics
WSES1520236X3	2 x 1.5 x 2.36m EDGE 3 sides storage kit
WSES15202363BL	2 x 1.5 x 2.36m EDGE 3 sides storage fabric graphics
WSES1530236X3	3 x 1.5 x 2.36m EDGE 3 sides storage kit
WSES15302363BLF	3 x 1.5 x 2.36m EDGE 3 sides storage fabric graphics

2.5m High

1m Deep

PRODUCT CODE	DESCRIPTION
WSES1010250X3	1 x 1 x 2.5m EDGE 3 sides storage kit
WSES10102503BLF	1 x 1 x 2.5m EDGE 3 sides storage fabric graphics
WSES1020250X3	2 x 1 x 2.5m EDGE 3 sides storage kit
WSES10202503BL	2 x 1 x 2.5m EDGE 3 sides storage fabric graphics
WSES1030250X3	3 x 1 x 2.5m EDGE 3 sides storage kit
WSES10302503BLF	3 x 1 x 2.5m EDGE 3 sides storage fabric graphics

1.5m Deep

WSES1510250X3	1 x 1.5 x 2.5m EDGE 3 sides storage kit
WSES15102503BLF	1 x 1.5 x 2.5m EDGE 3 sides storage fabric graphics
WSES1520250X3	2 x 1.5 x 2.5m EDGE 3 sides storage kit
WSES15202503BL	2 x 1.5 x 2.5m EDGE 3 sides storage fabric graphics
WSES1530250X3	3 x 1.5 x 2.5m EDGE 3 sides storage kit
WSES15302503BLF	3 x 1.5 x 2.5m EDGE 3 sides storage fabric graphics

3m High

1m Deep

PRODUCT CODE	DESCRIPTION
WSES1010300X3	1 x 1 x 3m EDGE 3 sides storage kit
WSES10103003BLF	1 x 1 x 3m EDGE 3 sides storage fabric graphics
WSES1020300X3	2 x 1 x 3m EDGE 3 sides storage kit
WSES10203003BL	2 x 1 x 3m EDGE 3 sides storage fabric graphics
WSES1030300X3	3 x 1 x 3m EDGE 3 sides storage kit
WSES10303003BLF	3 x 1 x 3m EDGE 3 sides storage fabric graphics

1.5m Deep

WSES1510300X3	1 x 1.5 x 3m EDGE 3 sides storage kit
WSES15103003BLF	1 x 1.5 x 3m EDGE 3 sides storage fabric graphics
WSES1520300X3	2 x 1.5 x 3m EDGE 3 sides storage kit
WSES15203003BL	2 x 1.5 x 3m EDGE 3 sides storage fabric graphics
WSES1530300X3	3 x 1.5 x 3m EDGE 3 sides storage kit
WSES15303003BLF	3 x 1.5 x 3m EDGE 3 sides storage fabric graphics

STORAGE BACKLIT SUMMARY - (2 SIDES VISIBLE)

2.36m High

1m Deep

PRODUCT CODE	DESCRIPTION
WSES1010236X2BL	1 x 1 x 2.36m EDGE 2 sides backlit storage kit
WSES10102362BLF	1 x 1 x 2.36m EDGE 2 sides backlit storage fabric graphics
WSLKLBL10I80BL	0.86 x 2.36m BrightWall 80 Lightblocker Panel
WSES1020236X2BL	2 x 1 x 2.36m EDGE 2 sides backlit storage kit
WSES10202362BLF	2 x 1 x 2.36m EDGE 2 sides backlit storage fabric graphics
WSLKLBL20I80BL	1.86 x 2.36m BrightWall 80 Lightblocker Panel
WSES1030236X2BL	3 x 1 x 2.36m EDGE 2 sides backlit storage kit
WSES10302362BLF	3 x 1 x 2.36m EDGE 2 sides backlit storage fabric graphics
WSLKLBL30I80BL	2.86 x 2.36m BrightWall 80 Lightblocker Panel

1.5m Deep

WSES1510236X2BL	1 x 1.5 x 2.36m EDGE 2 sides backlit storage kit
WSES15102362BLF	1 x 1.5 x 2.36m EDGE 2 sides backlit storage fabric graphics
WSLKLBL10I80BL	0.86 x 2.36m BrightWall 80 Lightblocker Panel
WSES1520236X2BL	2 x 1.5 x 2.36m EDGE 2 sides backlit storage kit
WSES15202362BLF	2 x 1.5 x 2.36m EDGE 2 sides backlit storage fabric graphics
WSLKLBL20I80BL	1.86 x 2.36m BrightWall 80 Lightblocker Panel
WSES1530236X2BL	3 x 1.5 x 2.36m EDGE 2 sides backlit storage kit
WSES15302362BLF	3 x 1.5 x 2.36m EDGE 2 sides backlit storage fabric graphics
WSLKLBL30I80BL	2.86 x 2.36m BrightWall 80 Lightblocker Panel

2.5m High

1m Deep

PRODUCT CODE	DESCRIPTION
WSES1010250X2BL	1 x 1 x 2.5m EDGE 2 sides backlit storage kit
WSES10102502BLF	1 x 1 x 2.5m EDGE 2 sides backlit storage fabric graphics
WSLKLBL1025I80BL	0.86 x 2.5m BrightWall 80 Lightblocker Panel
WSES1020250X2BL	2 x 1 x 2.5m EDGE 2 sides backlit storage kit
WSES10202502BLF	2 x 1 x 2.5m EDGE 2 sides backlit storage fabric graphics
WSLKLBL2025I80BL	1.36 x 2.5m BrightWall 80 lightblocker panel
WSES1030250X2BL	3 x 1 x 2.5m EDGE 2 sides backlit storage kit
WSES10302502BLF	3 x 1 x 2.5m EDGE 2 sides backlit storage fabric graphics
WSLKLBL3025I80BL	2.86 x 2.5m BrightWall 80 Lightblocker Panel

STORAGE BACKLIT SUMMARY - (2 SIDES VISIBLE)

1.5m Deep

PRODUCT CODE	DESCRIPTION
WSES1510250X2B	1 x 1.5 x 2.5m EDGE 2 sides backlit storage kit
WSES15102502BLF	1 x 1.5 x 2.5m EDGE 2 sides backlit storage fabric graphics
WSLKLBL1025I80BL	0.86 x 2.5m BrightWall 80 Lightblocker Panel
WSES1520250X2BL	2 x 1.5 x 2.5m EDGE 2 sides backlit storage kit
WSES15202502BLF	2 x 1.5 x 2.5m EDGE 2 sides backlit storage fabric graphics
WSLKLBL2025I80BL	1.36 x 2.5m BrightWall 80 lightblocker panel
WSES1530250X2BL	3 x 1.5 x 2.5m EDGE 2 sides backlit storage kit
WSES15302502BLF	3 x 1.5 x 2.5m EDGE 2 sides backlit storage fabric graphics
WSLKLBL3025I80BL	1.86 x 2.5m BrightWall 80 lightblocker panel

3m High

1m Deep

PRODUCT CODE	DESCRIPTION
WSES1010300X2BL	1 x 1 x 3m EDGE 2 sides backlit storage kit
WSES10103002BLF	1 x 1 x 3m EDGE 2 sides backlit storage fabric graphics
WSLKLBL1030I80BL	0.86 x 3m BrightWall 80 Lightblocker Panel
WSES1020300X2BL	2 x 1 x 3m EDGE 2 sides backlit storage kit
WSES10203002BLF	2 x 1 x 3m EDGE 2 sides backlit storage fabric graphics
WSLKLBL2030I80BL	1.86 x 3m BrightWall 80 Lightblocker Panel
WSES1030300X2BL	3 x 1 x 3m EDGE 2 sides backlit storage kit
WSES10303002BLF	3 x 1 x 3m EDGE 2 sides backlit storage fabric graphics
WSLKLBL3030I80BL	2.86 x 3m BrightWall 80 Lightblocker Panel

1.5m Deep

WSES1510300X2BL	1 x 1.5 x 3m EDGE 2 sides backlit storage kit
WSES15103002BLF	1 x 1.5 x 3m EDGE 2 sides backlit storage fabric graphics
WSLKLBL1030I80BL	0.86 x 3m BrightWall 80 Lightblocker Panel
WSES1520300X2BL	2 x 1.5 x 3m EDGE 2 sides backlit storage kit
WSES15203002BLF	2 x 1.5 x 3m EDGE 2 sides backlit storage fabric graphics
WSLKLBL2030I80BL	1.86 x 3m BrightWall 80 Lightblocker Panel
WSES1530300X2BL	3 x 1.5 x 3m EDGE 2 sides backlit storage kit
WSES15303002BLF	3 x 1.5 x 3m EDGE 2 sides backlit storage fabric graphics
WSLKLBL3030I80BL	2.86 x 3m BrightWall 80 Lightblocker Panel

STORAGE BACKLIT SUMMARY - (3 SIDES VISIBLE)

2.36m High

1m Deep

PRODUCT CODE	DESCRIPTION
WSES1010236X3BL	1 x 1 x 2.36m EDGE 3 sides backlit storage kit
WSES10102363BLF	1 x 1 x 2.36m EDGE 3 sides backlit storage fabric graphics
WSLKLBL10180BL	0.86 x 2.36m BrightWall 80 Lightblocker Panel
WSES1020236X3BL	2 x 1 x 2.36m EDGE 3 sides backlit storage kit
WSES10202363BLF	2 x 1 x 2.36m EDGE 3 sides backlit storage fabric graphics
WSLKLBL20180BL	1.86 x 2.36m BrightWall 80 Lightblocker Panel
WSES1030236X3BL	3 x 1 x 2.36m EDGE 3 sides backlit storage kit
WSES10302363BLF	3 x 1 x 2.36m EDGE 3 sides backlit storage fabric graphics
WSLKLBL30180BL	2.86 x 2.36m BrightWall 80 Lightblocker Panel

1.5m Deep

WSES1510236X3BL	1 x 1.5 x 2.36m EDGE 3 sides backlit storage kit
WSES15102363BLF	1 x 1.5 x 2.36m EDGE 3 sides backlit storage fabric graphics
WSLKLBL10180BL	0.86 x 2.36m BrightWall 80 Lightblocker Panel
WSES1520236X3BL	2 x 1.5 x 2.36m EDGE 3 sides backlit storage kit
WSES15202363BLF	2 x 1.5 x 2.36m EDGE 3 sides backlit storage fabric graphics
WSLKLBL20180BL	1.86 x 2.36m BrightWall 80 Lightblocker Panel
WSES1530236X3BL	3 x 1.5 x 2.36m EDGE 3 sides backlit storage kit
WSES15302363BLF	3 x 1.5 x 2.36m EDGE 3 sides backlit storage fabric graphics
WSLKLBL30180BL	2.86 x 2.36m BrightWall 80 Lightblocker Panel

2.5m High

1m Deep

PRODUCT CODE	DESCRIPTION
WSES1010250X3BL	1 x 1 x 2.5m EDGE 3 sides backlit storage kit
WSES10102503BLF	1 x 1 x 2.5m EDGE 3 sides backlit storage fabric graphics
WSLKLBL1025180BL	0.86 x 2.5m BrightWall 80 Lightblocker Panel
WSES1020250X3BL	2 x 1 x 2.5m EDGE 3 sides backlit storage kit
WSES10202503BLF	2 x 1 x 2.5m EDGE 3 sides backlit storage fabric graphics
WSLKLBL2025180BL	1.36 x 2.5m BrightWall 80 lightblocker panel
WSES1030250X3BL	3 x 1 x 2.5m EDGE 3 sides backlit storage kit
WSES10302503BLF	3 x 1 x 2.5m EDGE 3 sides backlit storage fabric graphics
WSLKLBL3025180BL	2.86 x 2.5m BrightWall 80 Lightblocker Panel

STORAGE BACKLIT SUMMARY - (3 SIDES VISIBLE)

1.5m Deep

PRODUCT CODE	DESCRIPTION
WSES1510250X3B	1 x 1.5 x 2.5m EDGE 3 sides backlit storage kit
WSES15102503BLF	1 x 1.5 x 2.5m EDGE 3 sides backlit storage fabric graphics
WSLKLBL1025I80BL	0.86 x 2.5m BrightWall 80 Lightblocker Panel
WSES1520250X3BL	2 x 1.5 x 2.5m EDGE 3 sides backlit storage kit
WSES15202503BLF	2 x 1.5 x 2.5m EDGE 3 sides backlit storage fabric graphics
WSLKLBL2025I80BL	1.36 x 2.5m BrightWall 80 lightblocker panel
WSES1530250X3BL	3 x 1.5 x 2.5m EDGE 3 sides backlit storage kit
WSES15302503BLF	3 x 1.5 x 2.5m EDGE 3 sides backlit storage fabric graphics
WSLKLBL3025I80BL	1.86 x 2.5m BrightWall 80 lightblocker panel

3m High

1m Deep

PRODUCT CODE	DESCRIPTION
WSES1010300X3BL	1 x 1 x 3m EDGE 3 sides backlit storage kit
WSES10103003BLF	1 x 1 x 3m EDGE 3 sides backlit storage fabric graphics
WSLKLBL1030I80BL	0.86 x 3m BrightWall 80 Lightblocker Panel
WSES1020300X3BL	2 x 1 x 3m EDGE 3 sides backlit storage kit
WSES10203003BLF	2 x 1 x 3m EDGE 3 sides backlit storage fabric graphics
WSLKLBL2030I80BL	1.86 x 3m BrightWall 80 Lightblocker Panel
WSES1030300X3BL	3 x 1 x 3m EDGE 3 sides backlit storage kit
WSES10303003BLF	3 x 1 x 3m EDGE 3 sides backlit storage fabric graphics
WSLKLBL3030I80BL	2.86 x 3m BrightWall 80 Lightblocker Panel

1.5m Deep

WSES1510300X3BL	1 x 1.5 x 3m EDGE 3 sides backlit storage kit
WSES1510300BLF	1 x 1.5 x 3m EDGE 3 sides backlit storage fabric graphics
WSLKLBL1030I80BL	0.86 x 3m BrightWall 80 Lightblocker Panel
WSES1520300XBL	2 x 1.5 x 3m EDGE 3 sides backlit storage kit
WSES15203003BLF	2 x 1.5 x 3m EDGE 3 sides backlit storage fabric graphics
WSLKLBL2030I80BL	1.86 x 3m BrightWall 80 Lightblocker Panel
WSES1530300X3BL	3 x 1.5 x 3m EDGE 2 sides backlit storage kit
WSES15303003BLF	3 x 1.5 x 3m EDGE 2 sides backlit storage fabric graphics
WSLKLBL3030I80BL	2.86 x 3m BrightWall 80 Lightblocker Panel

ARCH

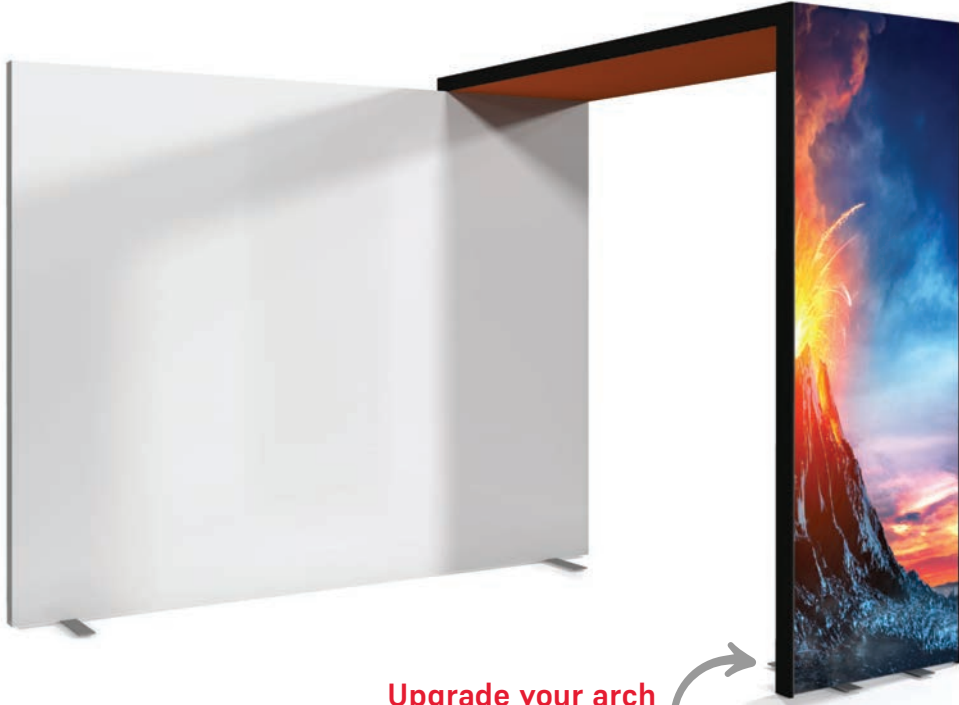

Upgrade your arch by adding endcaps.

UPGRADE

Upgrade your EDGE arch by adding our endcap extrusions in either anodised or powder coated (white/black). By using the endcap you get a smooth channel free finish to the outer edges of your arch.



NO ENDCAP AS STANDARD

ANODISED - SILVER



POWDER COATED - WHITE



POWDER COATED - BLACK



ARCH



Use this arch to connect onto one of our EDGE display walls. All our arches are available in a range of heights and depths meaning you are sure to find the right arch for you.

Connect our arches onto a 2.36m/2.5m/3m high EDGE display wall to add depth and impact to your exhibition.



Soar above your competition with our 3m high arches. Connect arches with our 2.36m high display walls and watch as your arch rises above your display to an impressive 3m high.

Be different and stand out at your next exhibition with one of our unique arches!

ARCH - (TYPE 1)



View our full range of
baseplates pg 11

All our arches are portable and easy to assemble, the arch below can be assembled in as little as 30 minutes. The arch is made up of 2 EDGE display walls combined with 2 of our external 'Y' connectors, each wall comes with 2 offset baseplates.



ARCH - (TYPE 1 - 2.36M HIGH)

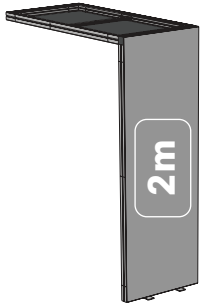

W 0.86m x D 2m x H 2.36m

	PRODUCT CODE	DESCRIPTION
Hardware	WSEA120236	0.86 x 2 x 2.36m EDGE arch type 1
Printed Fabric	WSEA120236F	0.86 x 2 x 2.36m EDGE arch type 1 fabric graphics
Endcap	WSEA120236ECK	EDGE arch type 1 - endcap kit - 0.86 x 2 x 2.36m

Product when assembled : W 860mm x H 2360mm x D 2000mm

Transport Case : 2 x Small Poly Case

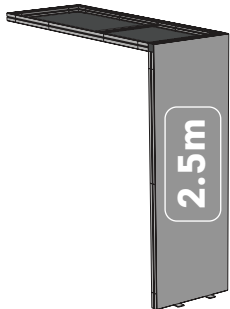

W 0.86m x D 2.5m x H 2.36m

	PRODUCT CODE	DESCRIPTION
Hardware	WSEA125236	0.86 x 2.5 x 2.36m EDGE arch type 1
Printed Fabric	WSEA125236F	0.86 x 2.5 x 2.36m EDGE arch type 1 fabric graphics
Endcap	WSEA125236ECK	EDGE arch type 1 - endcap kit - 0.86 x 2.5 x 2.36m

Product when assembled : W 860mm x H 2360mm x D 2500mm

Transport Case : 2 x Small Poly Case

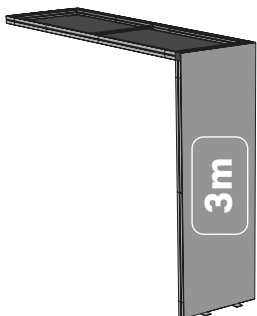

W 0.86m x D 3m x H 2.36m

	PRODUCT CODE	DESCRIPTION
Hardware	WSEA130236	0.86 x 3 x 2.36m EDGE arch type 1
Printed Fabric	WSEA130236F	0.86 x 3 x 2.36m EDGE arch type 1 fabric graphics
Endcap	WSEA130236ECK	EDGE arch type 1 - endcap kit - 0.86 x 3 x 2.36m

Product when assembled : W 860mm x H 2360mm x D 3000mm

Transport Case : 2 x Small Poly Case

*Custom sizes are available on request.

ARCH - (TYPE 1 - 2.5M HIGH)

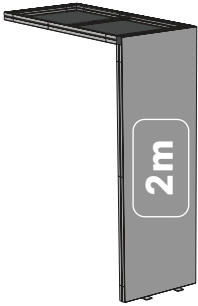

W 0.86m x D 2m x H 2.5m

	PRODUCT CODE	DESCRIPTION
Hardware	WSEA120250	0.86 x 2 x 2.5m EDGE arch type 1
Printed Fabric	WSEA120250F	0.86 x 2 x 2.5m EDGE arch type 1 fabric graphics
Endcap	WSEA120250ECK	EDGE arch type 1 - endcap kit - 0.86 x 2 x 2.5m

Product when assembled : W 860mm x H 2500mm x D 2000mm

Transport Case : 2 x Small Poly Case

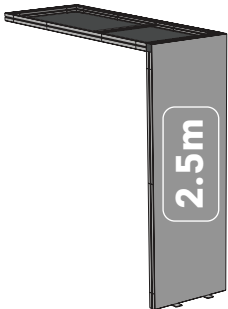

W 0.86m x D 2.5m x H 2.5m

	PRODUCT CODE	DESCRIPTION
Hardware	WSEA125250	0.86 x 2.5 x 2.5m EDGE arch type 1
Printed Fabric	WSEA125250F	0.86 x 2.5 x 2.5m EDGE arch type 1 fabric graphics
Endcap	WSEA125250ECK	EDGE arch type 1 - endcap kit - 0.86 x 2.5 x 2.5m

Product when assembled : W 860mm x H 2500mm x D 2500mm

Transport Case : 2 x Small Poly Case

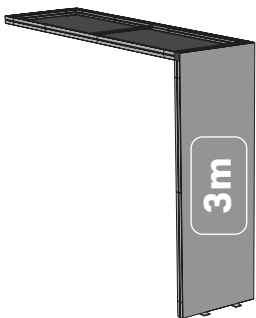

W 0.86m x D 3m x H 2.5m

	PRODUCT CODE	DESCRIPTION
Hardware	WSEA130250	0.86 x 3 x 2.5m EDGE arch type 1
Printed Fabric	WSEA130250F	0.86 x 3 x 2.5m EDGE arch type 1 fabric graphics
Endcap	WSEA130250ECK	EDGE arch type 1 - endcap kit - 0.86 x 3 x 2.5m

Product when assembled : W 860mm x H 2500mm x D 3000mm

Transport Case : 2 x Small Poly Case

ARCH - (TYPE 1 - 3M HIGH)

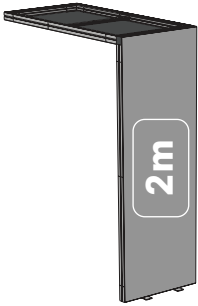

W 0.86m x D 2m x H 3m

	PRODUCT CODE	DESCRIPTION
Hardware	WSEA120300	0.86 x 2 x 3m EDGE arch type 1
Printed Fabric	WSEA120300F	0.86 x 2 x 3m EDGE arch type 1 fabric graphics
Endcap	WSEA120300ECK	EDGE arch type 1 - endcap kit - 0.86 x 2 x 3m

Product when assembled : W 860mm x H 3000mm x D 2000mm

Transport Case : 2 x Small Poly Case

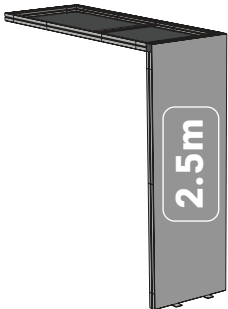

W 0.86m x D 2.5m x H 3m

	PRODUCT CODE	DESCRIPTION
Hardware	WSEA125300	0.86 x 2.5 x 3m EDGE arch type 1
Printed Fabric	WSEA125300F	0.86 x 2.5 x 3m EDGE arch type 1 fabric graphics
Endcap	WSEA125300ECK	EDGE arch type 1 - endcap kit - 0.86 x 2.5 x 3m

Product when assembled : W 860mm x H 3000mm x D 2500mm

Transport Case : 2 x Small Poly Case

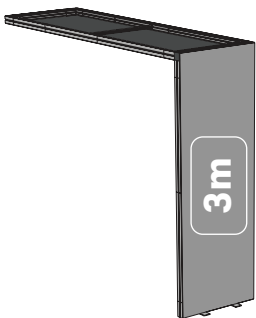

W 0.86m x D 3m x H 3m

	PRODUCT CODE	DESCRIPTION
Hardware	WSEA130300	0.86 x 3 x 3m EDGE arch type 1
Printed Fabric	WSEA130300F	0.86 x 3 x 3m EDGE arch type 1 fabric graphics
Endcap	WSEA130300ECK	EDGE arch type 1 - endcap kit - 0.86 x 3 x 3m

Product when assembled : W 860mm x H 3000mm x D 3000mm

Transport Case : 2 x Small Poly Case

*Custom sizes are available on request.

ARCH - (TYPE 2)



Create a bigger impact with our 'over the top' arch. This arch is made up of 3 EDGE display walls combined with 2 of our external 'Y' connectors, each wall comes with 2 offset baseplates.

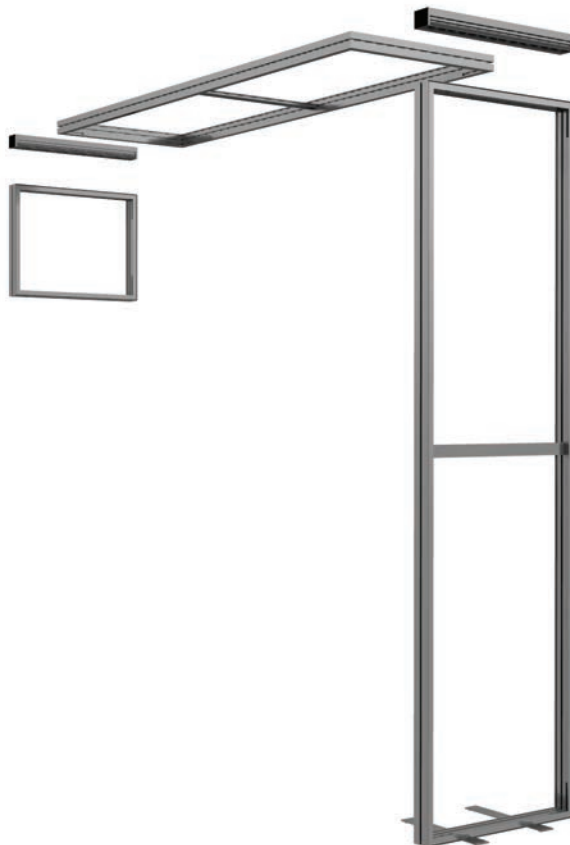

ARCH - (TYPE 2 - 3M HIGH)

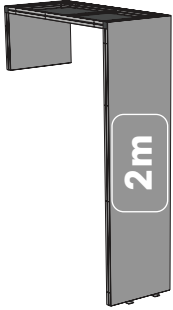

W 0.86m x D 2m x H 3m

	PRODUCT CODE	DESCRIPTION
Hardware	WSEA220300	0.86 x 2 x 3m EDGE arch type 2
Printed Fabric	WSEA220300F	0.86 x 2 x 3m EDGE arch type 2 fabric graphics
Endcap	WSEA220300ECK	EDGE arch type 2 - endcap kit - 0.86 x 2 x 3m

Product when assembled : W 860mm x H 3000mm x D 2000mm

Transport Case : 2 x Small Poly Case

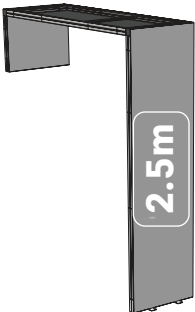

W 0.86m x D 2.5m x H 3m

	PRODUCT CODE	DESCRIPTION
Hardware	WSEA225300	0.86 x 2.5 x 3m EDGE arch type 2
Printed Fabric	WSEA225300F	0.86 x 2.5 x 3m EDGE arch type 2 fabric graphics
Endcap	WSEA225300ECK	EDGE arch type 2 - endcap kit - 0.86 x 2.5 x 3m

Product when assembled : W 860mm x H 3000mm x D 2500mm

Transport Case : 2 x Small Poly Case

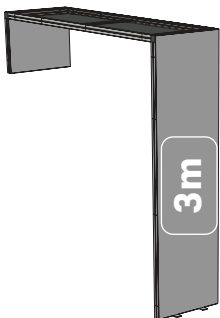

W 0.86m x D 3m x H 3m

	PRODUCT CODE	DESCRIPTION
Hardware	WSEA230300	0.86 x 3 x 3m EDGE arch type 2
Printed Fabric	WSEA230300F	0.86 x 3 x 3m EDGE arch type 2 fabric graphics
Endcap	WSEA230300ECK	EDGE arch type 2 - endcap kit - 0.86 x 3 x 3m

Product when assembled : W 860mm x H 3000mm x D 3000mm

Transport Case : 2 x Small Poly Case

*Custom sizes are available on request.

ARCH SUMMARY

TYPE 1

2.36m High

PRODUCT CODE	DESCRIPTION
WSEA120236	0.86 x 2 x 2.36m EDGE arch type 1
WSEA120236F	0.86 x 2 x 2.36m EDGE arch type 1 fabric graphics
WSEA120236ECK	EDGE arch type 1 - endcap kit - 0.86 x 2 x 2.36m
WSEA125236	0.86 x 2.5 x 2.36m EDGE arch type 1
WSEA125236F	0.86 x 2.5 x 2.36m EDGE arch type 1 fabric graphics
WSEA125236ECK	EDGE arch type 1 - endcap kit - 0.86 x 2.5 x 2.36m
WSEA130236	0.86 x 3 x 2.36m EDGE arch type 1
WSEA130236F	0.86 x 3 x 2.36m EDGE arch type 1 fabric graphics
WSEA130236ECK	EDGE arch type 1 - endcap kit - 0.86 x 3 x 2.36m

2.5m High

WSEA120250	0.86 x 2 x 2.5m EDGE arch type 1
WSEA120250F	0.86 x 2 x 2.5m EDGE arch type 1 fabric graphics
WSEA120250ECK	EDGE arch type 1 - endcap kit - 0.86 x 2 x 2.5m
WSEA125250	0.86 x 2.5 x 2.5m EDGE arch type 1
WSEA125250F	0.86 x 2.5 x 2.5m EDGE arch type 1 fabric graphics
WSEA125250ECK	EDGE arch type 1 - endcap kit - 0.86 x 2.5 x 2.5m
WSEA130250	0.86 x 3 x 2.5m EDGE arch type 1
WSEA130250F	0.86 x 3 x 2.5m EDGE arch type 1 fabric graphics
WSEA130250ECK	EDGE arch type 1 - endcap kit - 0.86 x 3 x 2.5m

3m High

WSEA120300	0.86 x 2 x 3m EDGE arch type 1
WSEA120300F	0.86 x 2 x 3m EDGE arch type 1 fabric graphics
WSEA120300ECK	EDGE arch type 1 - endcap kit - 0.86 x 2 x 3m
WSEA125300	0.86 x 2.5 x 3m EDGE arch type 1
WSEA125300F	0.86 x 2.5 x 3m EDGE arch type 1 fabric graphics
WSEA125300ECK	EDGE arch type 1 - endcap kit - 0.86 x 2.5 x 3m
WSEA130300	0.86 x 3 x 3m EDGE arch type 1
WSEA130300F	0.86 x 3 x 3m EDGE arch type 1 fabric graphics
WSEA130300ECK	EDGE arch type 1 - endcap kit - 0.86 x 3 x 3m

ARCH SUMMARY

TYPE 2

2.36m High

PRODUCT CODE	DESCRIPTION
WSEA220300	0.86 x 2 x 2.36m EDGE arch type 2
WSEA220300F	0.86 x 2 x 2.36m EDGE arch type 2 fabric graphics
WSEA220300ECK	EDGE arch type 2 - endcap kit - 0.86 x 2 x 2.36m
WSEA225300	0.86 x 2.5 x 2.36m EDGE arch type 2
WSEA225300F	0.86 x 2.5 x 2.36m EDGE arch type 2 fabric graphics
WSEA225300ECK	EDGE arch type 2 - endcap kit - 0.86 x 2.5 x 2.36m
WSEA230300	0.86 x 3 x 2.36m EDGE arch type 2
WSEA230300F	0.86 x 3 x 2.36m EDGE arch type 2 fabric graphics
WSEA230300ECK	EDGE arch type 2 - endcap kit - 0.86 x 3 x 2.36m

DETAILED SETUP INSTRUCTIONS

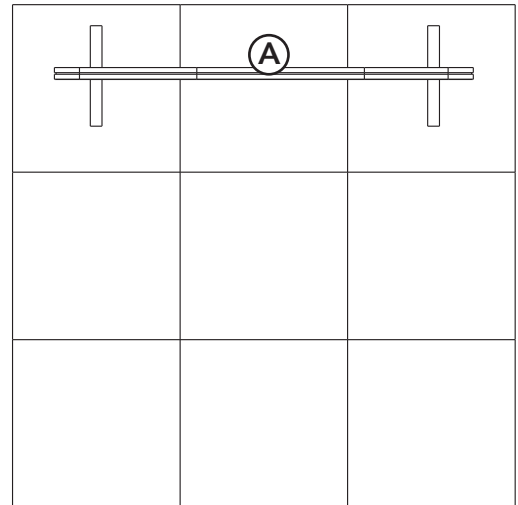
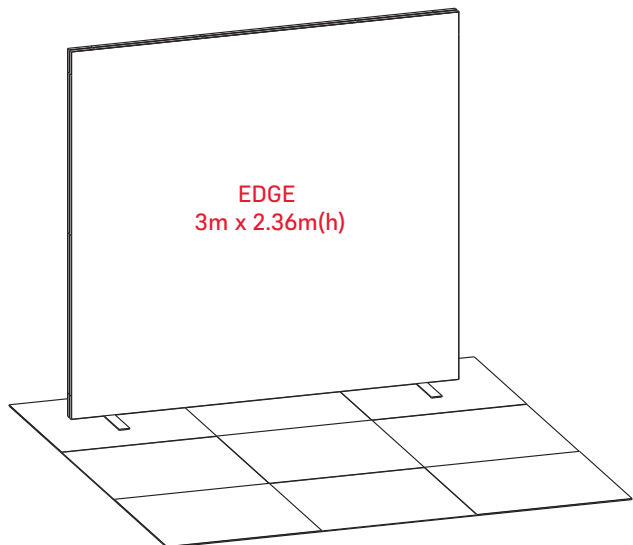

1 Locate the walls in each case, beginning with Wall A to begin assembly.

2 Locate component A1 in the corresponding case and begin assembly from the starting point. Each of the components are individually numbered and has a drawing that explains its location and installation.

3 Follow the numbering sequence to complete each section of the stand.

GENERAL ASSEMBLY

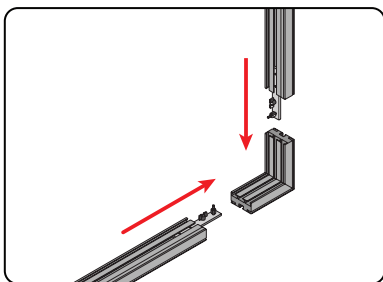

1 Join pre assembled corners by sliding onto the pre-installed sliders located on the horizontal and vertical extrusions and tightening the thumbscrews.

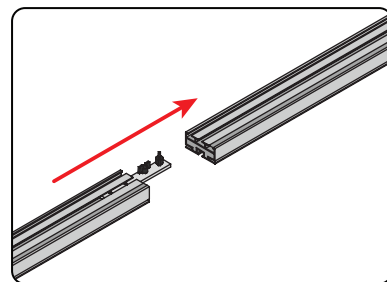

2 Join horizontal and vertical extrusions by sliding onto the pre-installed sliders located on the horizontal and vertical extrusions and tightening the thumbscrews.

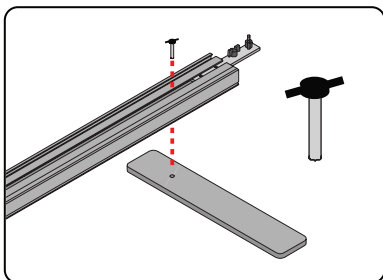

3 Connect the base plates to the EDGE frame using the M8 thumbscrews provided as shown above.

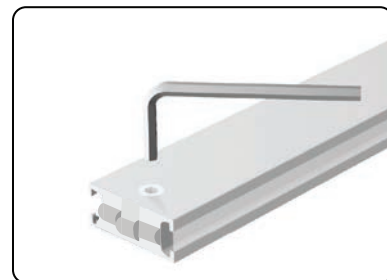

4 The internal extrusions are locked into position in the middle channel of the frame. To lock into position turn the camlock 180 degrees using the allen key provided.

DETAILED SETUP INSTRUCTIONS

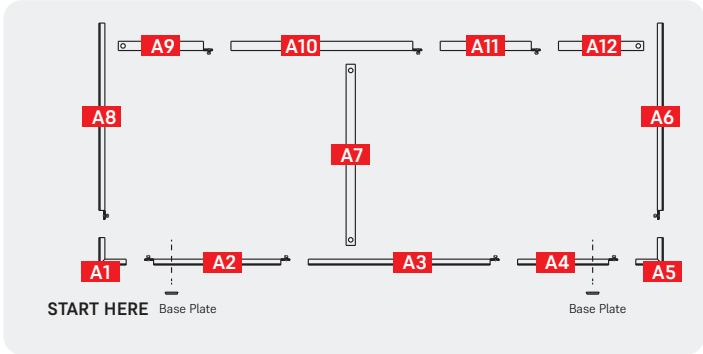

BOTTOM HALF

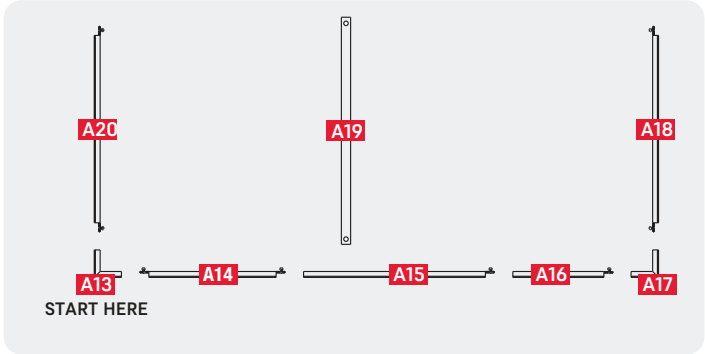

TOP HALF

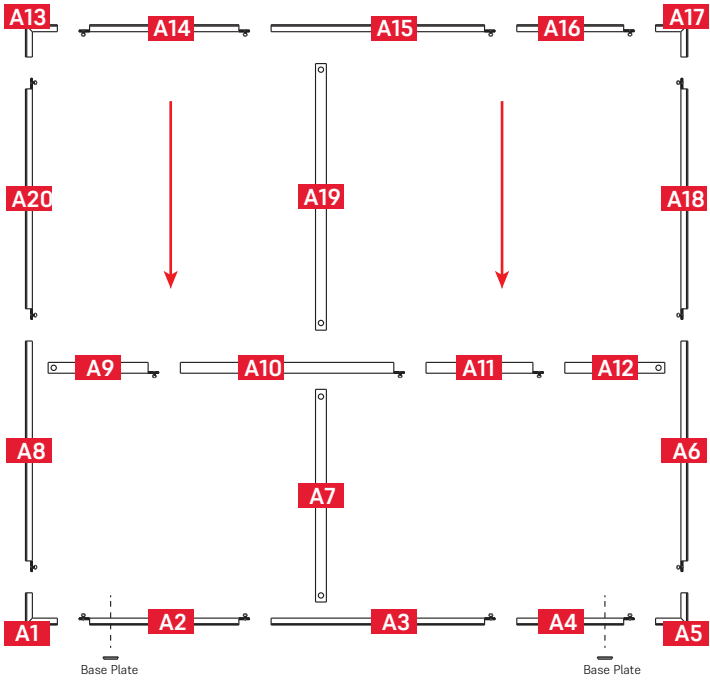

ASSEMBLY NOTES

- 1
 Build the bottom half A1 to A12 (Refer to the EDGE General Assembly page for assistance).
- 2
 Build the top half A13 to A20 (Refer to the EDGE General Assembly page for assistance).
- 3
 Connect the top half to the bottom half.

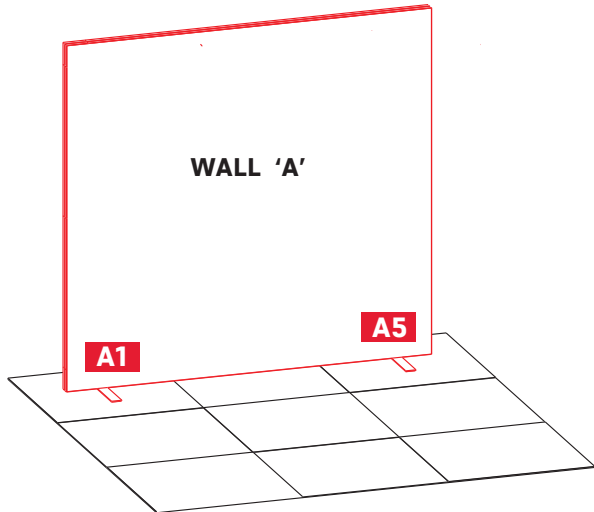

DETAILED SETUP INSTRUCTIONS

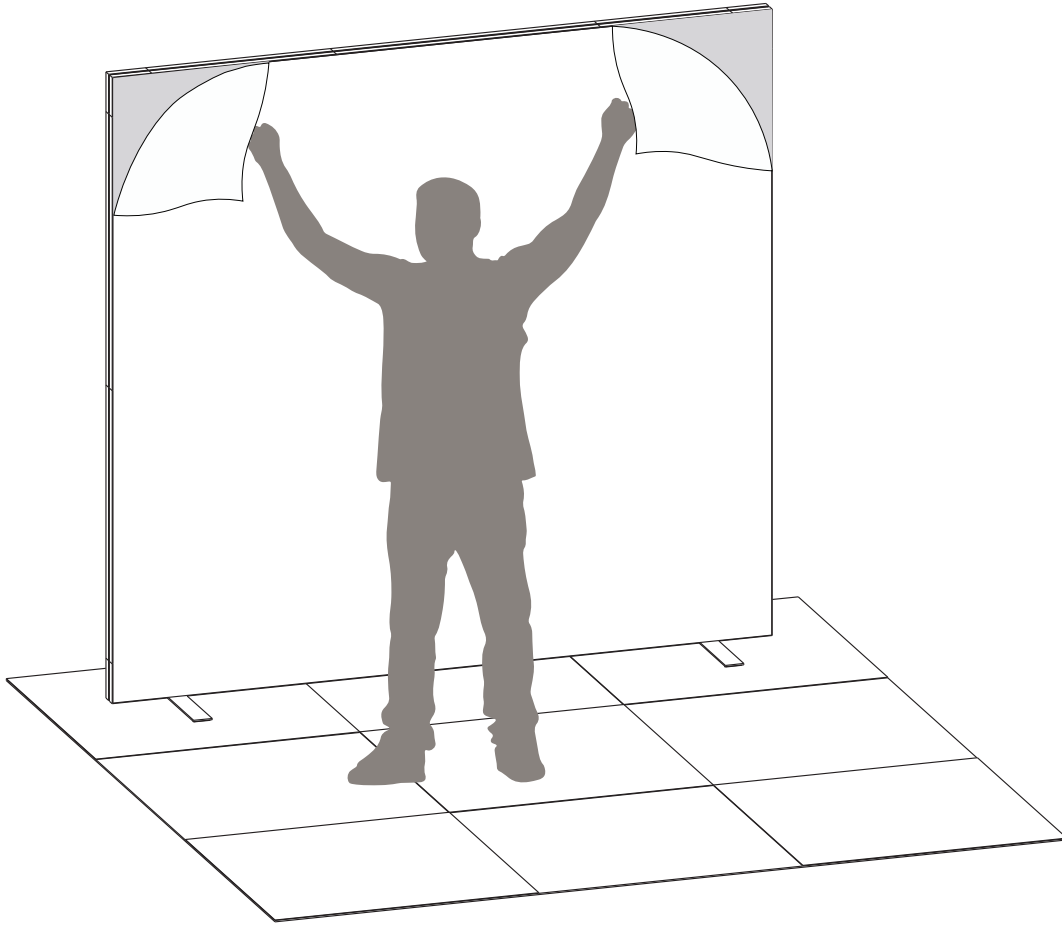

ASSEMBLY DETAIL

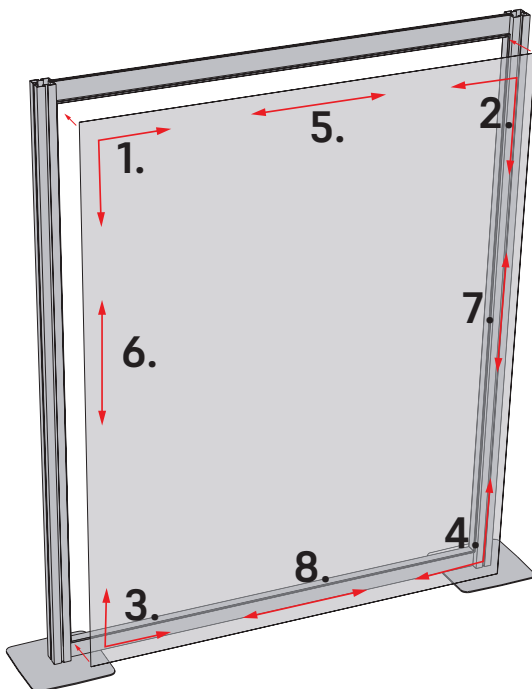

To place each Fabric Panel in position follow the numbering sequence above, gently pushing Silicon Bead on Fabric into Plastic T rack, until the fabric is tight. Use gloves provided.

NOTES

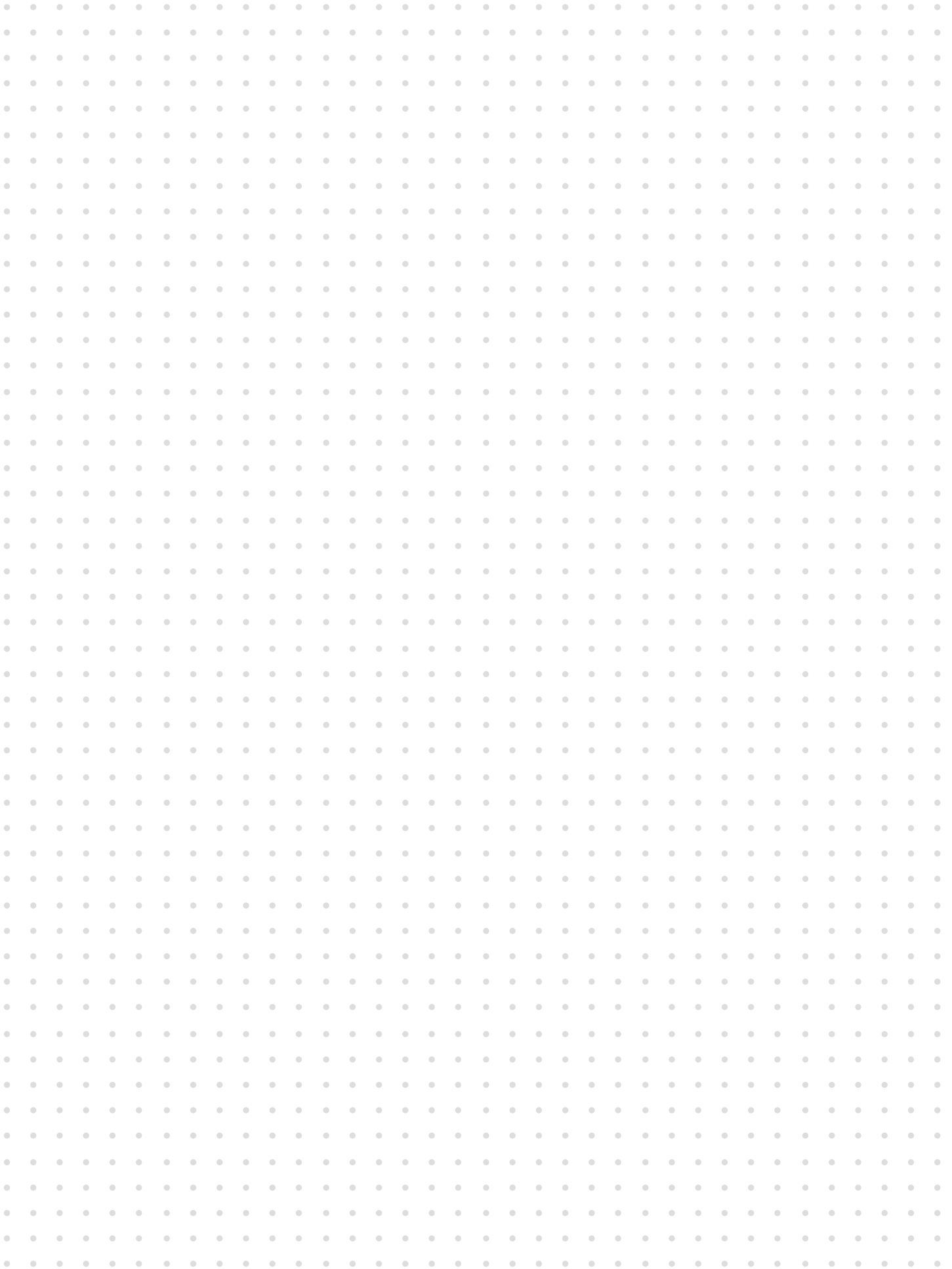



JEROME GANNON
Managing Director



With over 40 years of industry expertise, Nomadic Display stands as a beacon of unmatched craftsmanship, proudly made in Europe. Our legacy is built on delivering exceptional quality and innovative designs that stand the test of time, ensuring your brand makes a memorable impact on the global stage



Caher, Louisburgh,
Co. Mayo, F28P660



+353 98 66011



sales@nomadicdisplay.eu