

Nomadic Display[®]

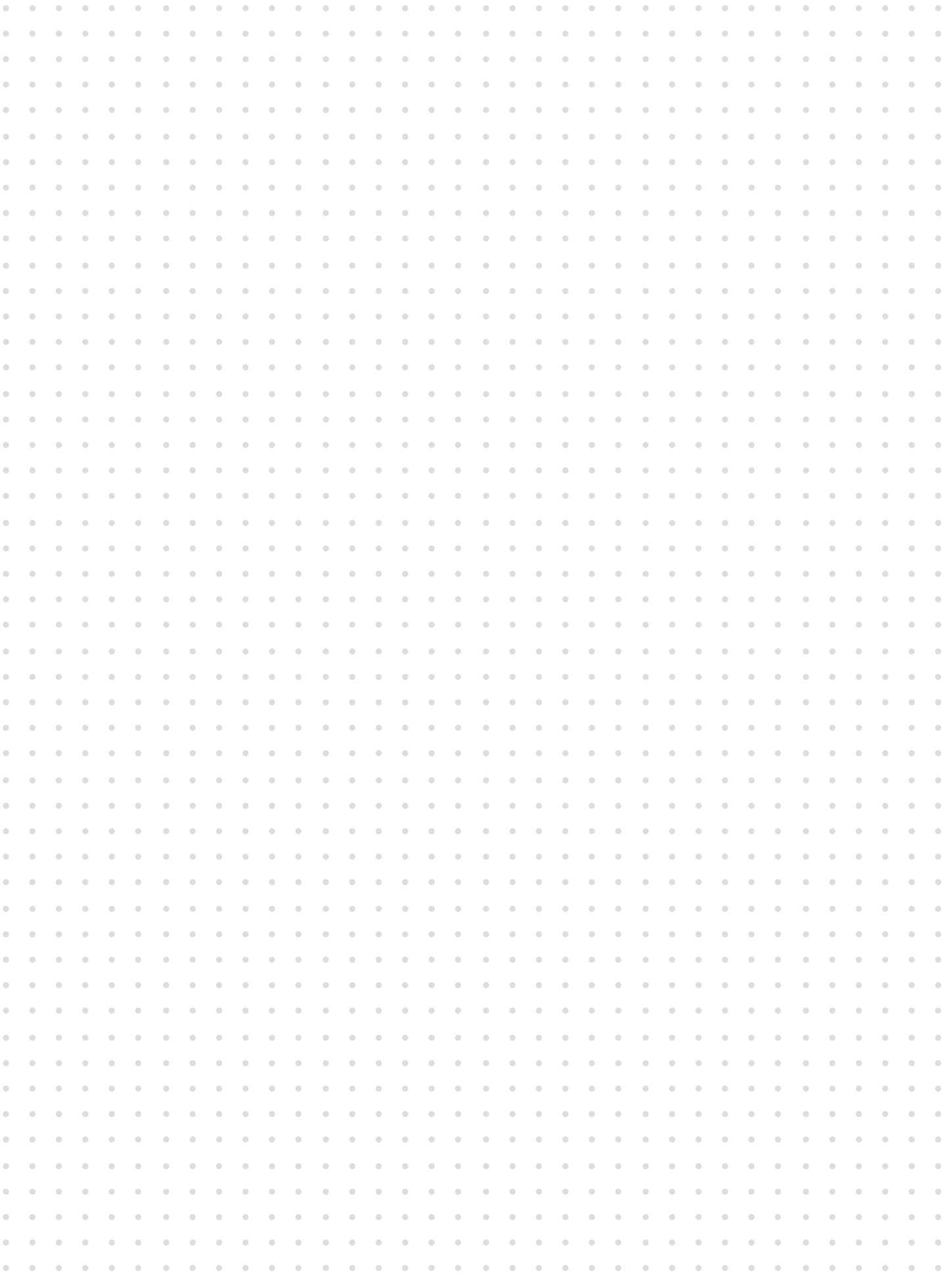

INSTAND[®] PRODUCT CATALOGUE

NOTES





WHY CHOOSE **NOMADIC DISPLAY** AS YOUR EXHIBITION PARTNER ?

With a rich history and unmatched expertise, Nomadic Display remains the go-to choice for businesses worldwide.



PIONEERING LEGACY

Nomadic Display pioneered the exhibition industry over 40 years ago with Ted Zeigler's invention of the "Pop Up Stand." When you partner with us, you're tapping into decades of groundbreaking design and unparalleled expertise.



UNMATCHED PRODUCT DIVERSITY

From Modular Stands to LED Backlit Displays, we offer a diverse range of products tailored to every need. Our dedication to innovation ensures that we consistently go beyond client expectations.



COMMITMENT TO CLIENT SUCCESS

At Nomadic Display, we don't just focus on transactions; we emphasize building genuine partnerships with our clients. By ensuring mutual success, we take pride in our dedicated team that offers exceptional post-purchase support to every customer.



40+

Years of Experience in the
Exhibition Industry



100+

Award Winning
Projects



20,000+

Satisfied Clients

OUR CORE VALUES



Partnerships



Sustainability



Quality



Professionalism



Innovation



Integrity

At the core of everything we do lies professionalism, integrity, innovation, and sustainability. Our mission is to forge lasting strategic partnerships with our customers. We are committed to setting the benchmark in the exhibition and display industries, delivering high-quality products with a guarantee of 100% satisfaction.



ABOUT US

 Made in Europe

Our team at Nomadic Display has been working for over 40 years to help you get the most out of your time spent at trade shows, exhibitions, and other sales events. The exhibition stands we create are some of the most innovative and economical in the industry, and they provide real returns for our clients, both now and in the future.

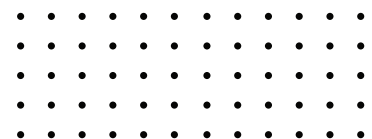

GREEN COMMITMENT

A DEVOTION TO ENVIRONMENTAL LEADERSHIP IN THE EXHIBITION INDUSTRY

Since our inception, Nomadic Display has championed sustainability. We're an eco-conscious company, always innovating to optimize our energy and resource use. Our commitment runs deep, evidenced by our efforts to curtail our carbon footprint, reduce waste, and conserve water.



SEAMLESS ADAPTABILITY

Our products are masterfully designed to cater to multiple events, not only minimizing waste but also maximizing your investment. Each product's versatility ensures adaptability across your exhibition calendar.

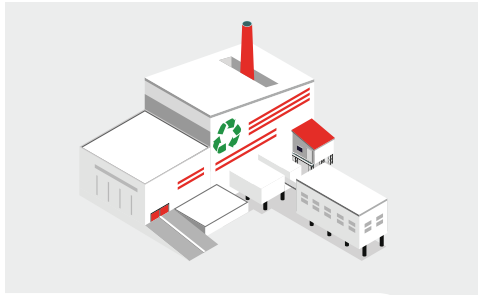

EARTH-CONSCIOUS CRAFTING

At the foundation of our production is high-quality, recycled materials. Our eco-friendly manufacturing goes beyond mere processes; it's our commitment to the planet. Even in the rare instances of wastage, we prioritize recycling and repurposing.

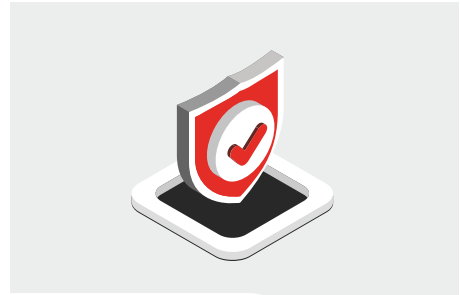

TIMELESS DURABILITY

We don't just create products; we build legacies. Our items are designed for longevity and to withstand repeated use. Every piece we create is backed by our unwavering warranties, a testament to our faith in their durability.

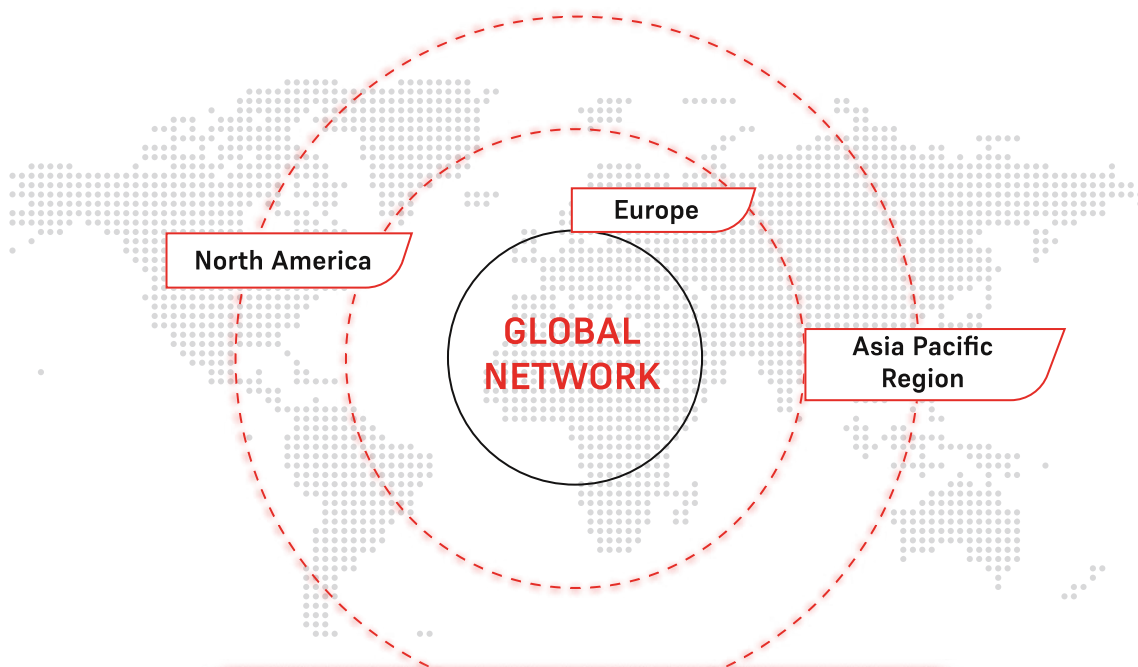

We are available all around the world through our extensive distribution network

EXHIBITION SERVICES

YOUR ONE-STOP SOLUTION FOR SEAMLESS EXHIBITIONS

At Nomadic Display, we understand the intricacies of the exhibition world. That's why we offer a comprehensive range of services designed to make your exhibition journey smooth and hassle-free.

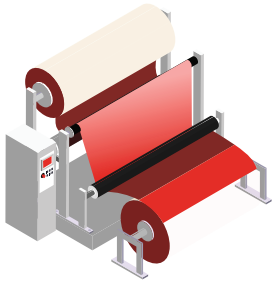

**IN-HOUSE
PRINTING**

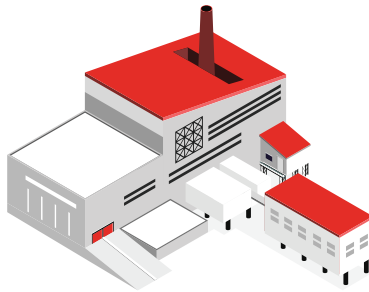

**EXHIBITION STAND
MANUFACTURING**



**GLOBAL EXHIBITION
STAND INSTALLATION**



**EXHIBITION
STAND RENTAL**

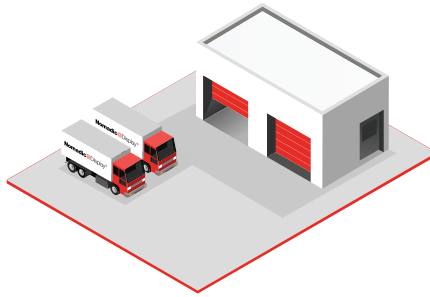

**EXHIBITION
STORAGE**



**24/7
SUPPORT**



**EXHIBITION STAND
DESIGN**

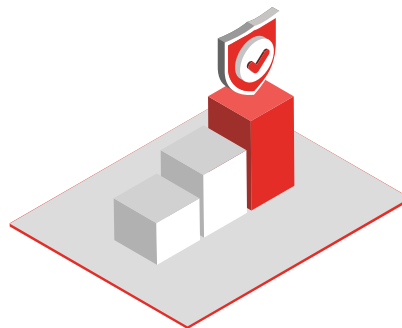

**INDUSTRY LEADING
WARRANTIES**

At Nomadic Display, we pride ourselves on offering a comprehensive suite of exhibition solutions tailored to meet the diverse needs of businesses worldwide. Our commitment to innovation, quality, and versatility shines through in every product we craft.

OUR PREMIER PRODUCT CATEGORIES

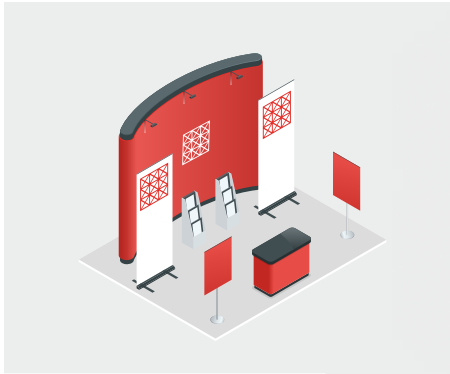

MODULAR EXHIBITION STANDS

Crafted for flexibility and impact, our modular stands can be tailored to fit any exhibition space, ensuring your brand remains the focal point.

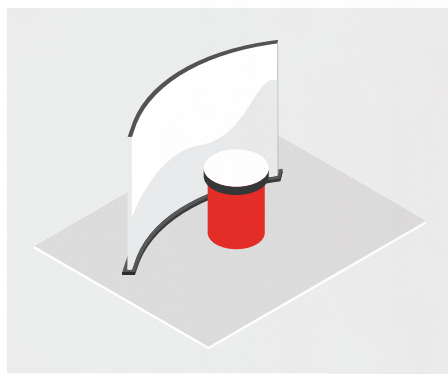

POP-UP STANDS

As the pioneers of the Pop Up Stand, we offer lightweight and portable options that are perfect for exhibitors on the go, ensuring a grand impression in any setting.

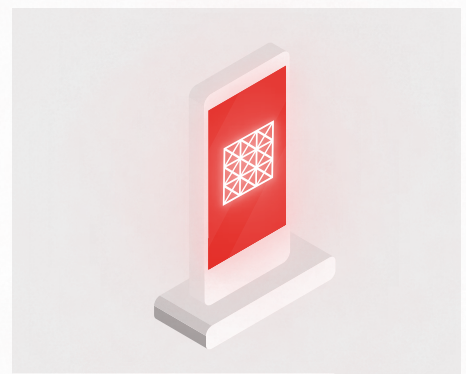

LED BACKLIT DISPLAYS

Illuminate your brand message with our state-of-the-art LED backlit displays. Designed to captivate and engage, these displays are a beacon of innovation.

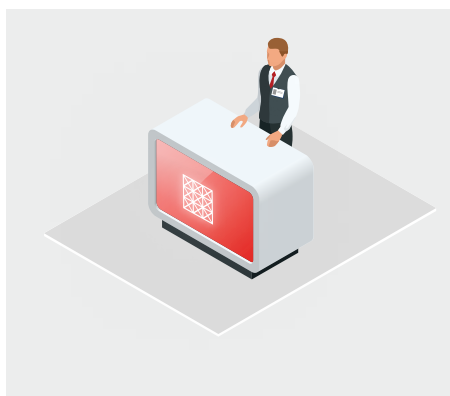

LED BACKLIT COUNTERS

Combine functionality with aesthetics. Our LED backlit counters not only serve as an interactive space but also enhance the ambiance of your exhibition area.

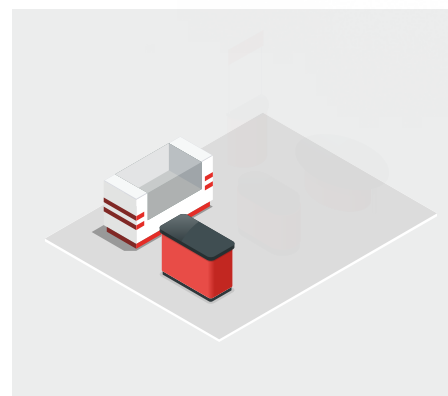

EXHIBITION COUNTERS

From product showcases to interactive hubs, our range of exhibition counters are designed to be both practical and visually appealing.



EXHIBITION ACCESSORIES

Complete your exhibition setup with our curated range of accessories. From lighting solutions to graphic panels, we've got everything you need to enhance your display.

OUR CLIENTELE

Over the years, we have established ourselves as a trusted name in the exhibition industry. Our journey began with a simple vision: to provide unparalleled products and services that would help businesses showcase their brands in the best light possible. Today, we are proud to say that we have turned that vision into a reality.

JOIN **20,000+** SATISFIED CLIENTS
GLOBALLY IN TRUSTING **NOMADIC
DISPLAY**

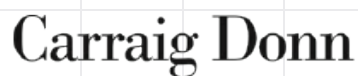

OUR EXHIBITION SOLUTIONS ARE CERTIFIED FOR EXCELLENCE

At Nomadic Display, our exhibition solutions are certified under three categories, upholding industry standards for quality, safety, and performance. Rest assured, our products are crafted to provide you with the best possible display experience.



NOMADIC INSTAND® INSTAND KITS EXPLAINED

Choose your Basic Kit

Instand Basic kits provide you with the essential components you need to 'pop-up' your display. Your basic kit includes:

1

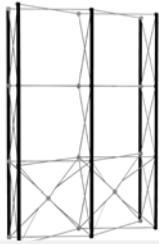

Frames



Magnetic Struts

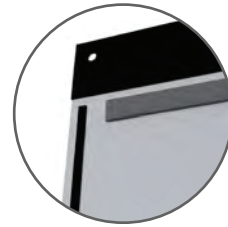

Photo Mural Kit
Stiffners, Magnet & Tape

Choose your Case

Nomadic Display have a range of cases available, simply select the case best suited to your needs.

2



RollOne Case



RollPlus 33 Case



RollEase Case

Upgrade it!

Upgrade your display by adding LED or halogen downlights and a countertop to turn your transport case into a counter.

3



LED Lights



RollOne Countertop

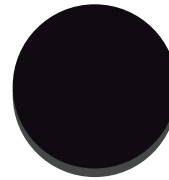

RollPlus Insert
Counter top

Accessorise it!

4

Nomadic Display has one of the largest ranges of accessories for your pop-up display, whether you want to showcase your new product or show off your new video we have an accessory for you.



INSTAND[®] CLASSIC



C31

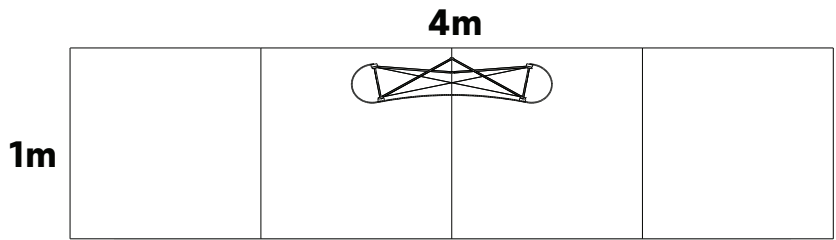

Assembled Dimensions
2.36m H x 1.05m W x 0.24m D

BASIC KITS



CODE | **CLASS31RP**

CONTENTS |
**C31 BASIC KIT IN A
ROLLPLUS 33 CASE**

- 1 x C31 Frame
- 4 x Magnetic Struts
- 1 x C31 Photo Mural Kit
- 1 x RollPlus 33 Case

15KG



CODE | **CLASS31RE**

CONTENTS |
**C31 BASIC KIT IN A
ROLLEASE CASE**

- 1 x C31 Frame
- 4 x Magnetic Struts
- 1 x C31 Photo Mural Kit
- 1 x RollEase Case

16KG



CODE | **CLASS31RO**

CONTENTS |
**C31 BASIC KIT IN A
ROLLEONE CASE**

- 1 x C31 Frame
- 4 x Magnetic Struts
- 1 x C31 Photo Mural Kit
- 1 x RollOne Case

21KG



C31

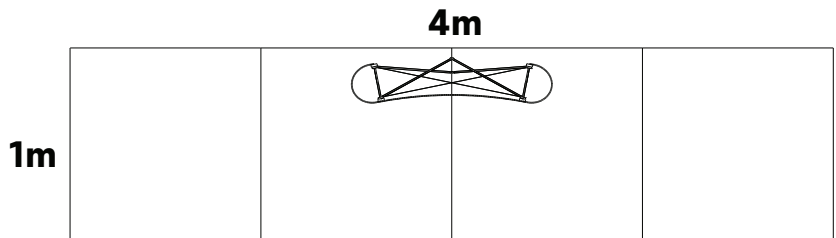

Assembled Dimensions
2.36m H x 1.05m W x 0.24m D

BASIC KITS WITH GRAPHICS



CODE | **CLASS31RPG**

CONTENTS |

C31 BASIC KIT WITH GRAPHICS IN A ROLLPLUS 33 CASE

- 1 x C31 Frame
- 4 x Magnetic Struts
- 1 x RollPlus 33 Case
- 1 x Set of Graphics

19KG



CODE | **CLASS31REG**

CONTENTS |

C31 BASIC KIT WITH GRAPHICS IN A ROLLEASE CASE

- 1 x C31 Frame
- 4 x Magnetic Struts
- 1 x RollEase Case
- 1 x Set of Graphics

20KG



CODE | **CLASS31ROG**

CONTENTS |

C31 BASIC KIT WITH GRAPHICS IN A ROLLONE CASE

- 1 x C31 Frame
- 4 x Magnetic Struts
- 1 x RollOne Case
- 1 x Set of Graphics with Wrap

25KG



C31

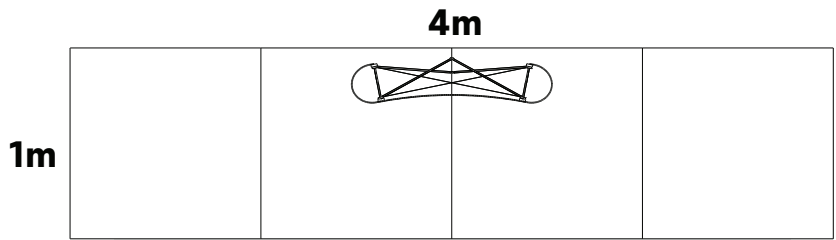

Assembled Dimensions
2.36m H x 1.05m W x 0.24m D

PREMIUM KITS



CODE | **CLASS31RP**

CONTENTS |
C31 BASIC KIT IN A ROLLPLUS 33 CASE

- 1 x C31 Frame
- 4 x Magnetic Struts
- 1 x C31 Photo Mural Kit
- 1 x RollPlus 33 Case
- 1 x Set of 2 lights

17KG



CODE | **CLASS31RE**

CONTENTS |
C31 BASIC KIT IN A ROLLEASE CASE

- 1 x C31 Frame
- 4 x Magnetic Struts
- 1 x C31 Photo Mural Kit
- 1 x RollEase Case
- 1 x Set of 2 Lights

18KG



CODE | **CLASS31RO**

CONTENTS |
C31 BASIC KIT IN A ROLLONE CASE

- 1 x C31 Frame
- 4 x Magnetic Struts
- 1 x C31 Photo Mural Kit
- 1 x RollOne Case
- 1 x Set of 2 Lights
- 1 x Counter Top

27KG



C31

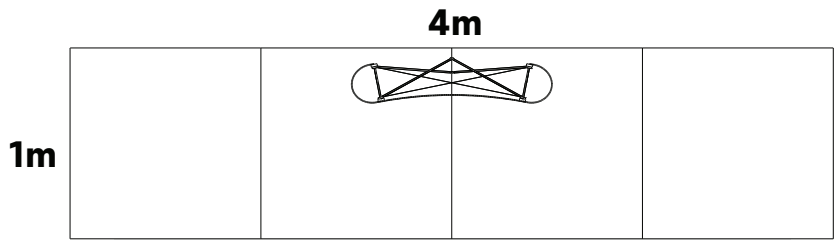

Assembled Dimensions
2.36m H x 1.05m W x 0.24m D

PREMIUM KITS WITH GRAPHICS



CODE | **CLASS31RP**

CONTENTS |

C31 BASIC KIT IN A ROLLPLUS 33 CASE

- 1 x C31 Frame
- 4 x Magnetic Struts
- 1 x RollPlus 33 Case
- 1 x Set of Graphics
- 1 x Set of 2 Lights

21KG



CODE | **CLASS31RE**

CONTENTS |

C31 BASIC KIT IN A ROLLEASE CASE

- 1 x C31 Frame
- 4 x Magnetic Struts
- 1 x RollEase Case
- 1 x Set of Graphics
- 1 x Set of 2 Lights

22KG



CODE | **CLASS31RO**

CONTENTS |

C31 BASIC KIT IN A ROLLONE CASE

- 1 x C31 Frame
- 4 x Magnetic Struts
- 1 x RollOne Case
- 1 x Set of Graphics with wrap
- 1 x Set of 2 Lights
- 1 x Counter Top

32KG



C32

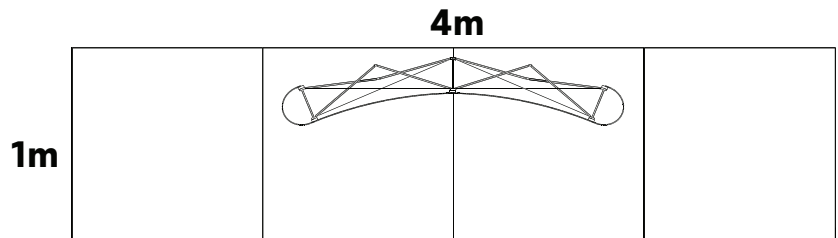

Assembled Dimensions
2.36m H x 1.37m W x 0.35m D

BASIC KITS



CODE | **CLASS32RP**

CONTENTS |
C32 BASIC KIT IN A ROLLPLUS 33 CASE

- 1 x C32 Frame
- 5 x Magnetic Struts
- 1 x C32 Photo Mural Kit
- 1 x RollPlus 33 Case

17KG



CODE | **CLASS32RE**

CONTENTS |
C32 BASIC KIT IN A ROLLEASE CASE

- 1 x C32 Frame
- 5 x Magnetic Struts
- 1 x C32 Photo Mural Kit
- 1 x Rollease Case

18KG



CODE | **CLASS32RO**

CONTENTS |
C32 BASIC KIT IN A ROLLEONE CASE

- 1 x C32 Frame
- 5 x Magnetic Struts
- 1 x C32 Photo Mural Kit
- 1 x RollOne Case

23KG



C32

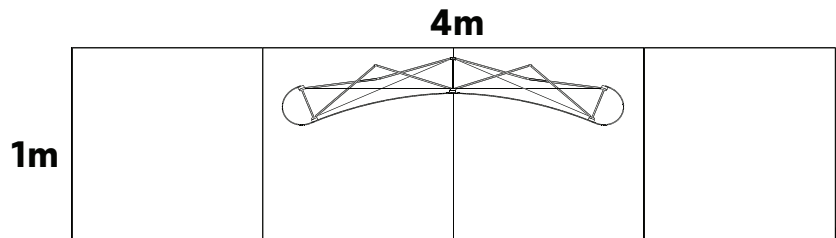

Assembled Dimensions
2.36m H x 1.37m W x 0.35m D

BASIC KITS WITH GRAPHICS



CODE | **CLASS32RPG**

CONTENTS |
**C32 BASIC KIT WITH GRAPHICS
IN A ROLLPLUS 33 CASE**

- 1 x C32 Frame
- 5 x Magnetic Struts
- 1 x RollPlus 33 Case
- 1 x Set of Graphics

23KG



CODE | **CLASS32REG**

CONTENTS |
**C31 BASIC KIT WITH GRAPHICS
IN A ROLLEASE CASE**

- 1 x C32 Frame
- 5 x Magnetic Struts
- 1 x RollEase Case
- 1 x Set of Graphics

24KG



CODE | **CLASS32ROG**

CONTENTS |
**C32 BASIC KIT WITH GRAPHICS
IN A ROLLONE CASE**

- 1 x C32 Frame
- 5 x Magnetic Struts
- 1 x C32 Photo Mural Kit
- 1 x C32 Photo Mural Kit
- 1 x Set of Graphics with wrap

29KG



C32

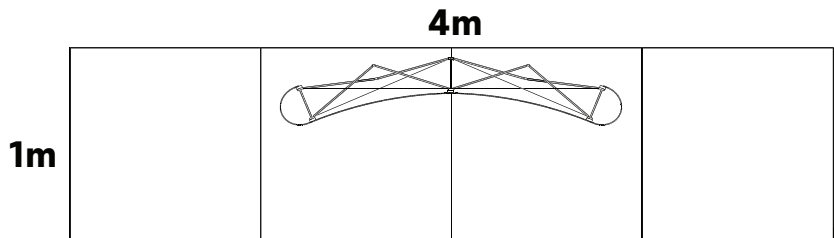

Assembled Dimensions
2.36m H x 1.37m W x 0.35m D

PREMIUM KITS



CODE | **CLASS32RP**

CONTENTS |
C32 BASIC KIT IN A ROLLPLUS 33 CASE

- 1 x C32 Frame
- 5 x Magnetic Struts
- 1 x C32 Photo Mural Kit
- 1 x RollPlus 33 Case
- 1 x Set of 2 lights

19KG



CODE | **CLASS32RE**

CONTENTS |
C32 BASIC KIT IN A ROLLEASE CASE

- 1 x C32 Frame
- 5 x Magnetic Struts
- 1 x C32 Photo Mural Kit
- 1 x RollEase Case
- 1 x Set of 2 Lights

20KG



CODE | **CLASS32RO**

CONTENTS |
C32 BASIC KIT IN A ROLLONE CASE

- 1 x C32 Frame
- 5 x Magnetic Struts
- 1 x C32 Photo Mural Kit
- 1 x RollOne Case
- 1 x Set of 2 Lights
- 1 x Counter Top

29KG



C32

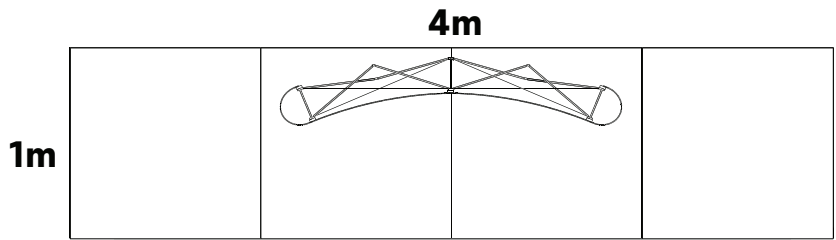

Assembled Dimensions
2.36m H x 1.37m W x 0.35m D

PREMIUM KITS WITH GRAPHICS



CODE | CLASS32RP

CONTENTS | C32 BASIC KIT IN A ROLLPLUS 33 CASE

- 1 x C32 Frame
- 5 x Magnetic Struts
- 1 x RollPlus 33 Case
- 1 x Set of Graphics
- 1 x Set of 2 Lights

25KG



CODE | CLASS32RE

CONTENTS | C32 BASIC KIT IN A ROLLEASE CASE

- 1 x C32 Frame
- 5 x Magnetic Struts
- 1 x RollEase Case
- 1 x Set of Graphics
- 1 x Set of 2 Lights

26KG



CODE | CLASS32RO

CONTENTS | C32 BASIC KIT IN A ROLLONE CASE

- 1 x C32 Frame
- 5 x Magnetic Struts
- 1 x RollOne Case
- 1 x Set of Graphics with wrap
- 1 x Set of 2 Lights
- 1 x Counter Top

36KG



C33

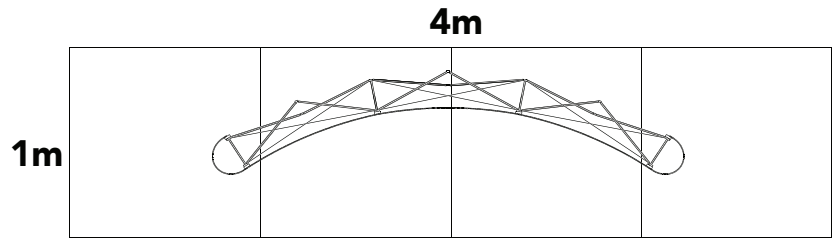

Assembled Dimensions
2.36m H x 2.485m W x 0.55m D

BASIC KITS



CODE | **CLASS33RP**

CONTENTS |
C33 BASIC KIT IN A ROLLPLUS 33 CASE

- 1 x C33 Frame
- 6 x Magnetic Struts
- 1 x C33 Photo Mural Kit
- 1 x RollPlus 33 Case

19KG



CODE | **CLASS33RE**

CONTENTS |
C33 BASIC KIT IN A ROLLEASE CASE

- 1 x C33 Frame
- 6 x Magnetic Struts
- 1 x C33 Photo Mural Kit
- 1 x Rollease Case

20KG



CODE | **CLASS33RO**

CONTENTS |
C33 BASIC KIT IN A ROLLEONE CASE

- 1 x C33 Frame
- 6 x Magnetic Struts
- 1 x C33 Photo Mural Kit
- 1 x RollOne Case

25KG



C33

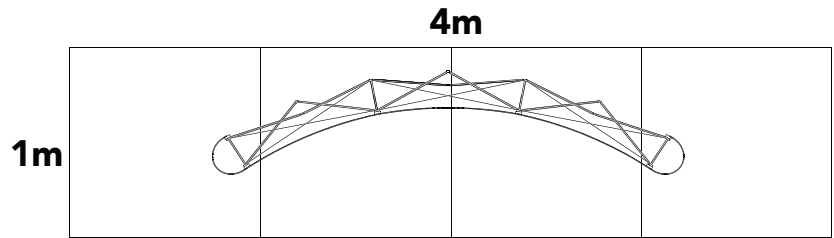

Assembled Dimensions
2.36m H x 2.485m W x 0.55m D

BASIC KITS WITH GRAPHICS



CODE | **CLASS31RPG**

CONTENTS |
**C33 BASIC KIT WITH GRAPHICS
IN A ROLLPLUS 33 CASE**

- 1 x C33 Frame
- 6 x Magnetic Struts
- 1 x RollPlus 33 Case
- 1 x Set of Graphics

27KG



CODE | **CLASS33REG**

CONTENTS |
**C33 BASIC KIT WITH GRAPHICS
IN A ROLLEASE CASE**

- 1 x C33 Frame
- 6 x Magnetic Struts
- 1 x RollEase Case
- 1 x Set of Graphics

28KG



CODE | **CLASS33ROG**

CONTENTS |
**C33 BASIC KIT WITH GRAPHICS
IN A ROLLONE CASE**

- 1 x C33 Frame
- 6 x Magnetic Struts
- 1 x RollOne Case
- 1 x Set of Graphics with Wrap

33KG



C33

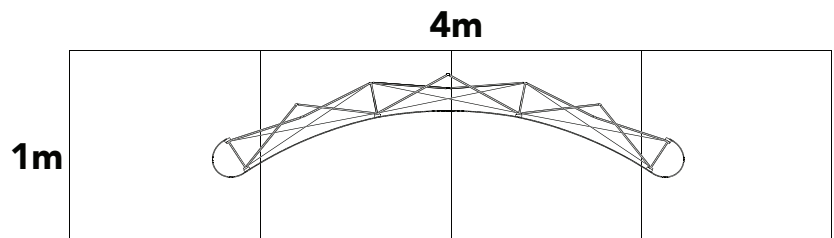

Assembled Dimensions
2.36m H x 2.485m W x 0.55m D

PREMIUM KITS



CODE | **CLASS33RP**

CONTENTS |
C33 BASIC KIT IN A ROLLPLUS 33 CASE

- 1 x C33 Frame
- 6 x Magnetic Struts
- 1 x C33 Photo Mural Kit
- 1 x RollPlus 33 Case
- 1 x Set of 2 lights

21KG



CODE | **CLASS33RE**

CONTENTS |
C33 BASIC KIT IN A ROLLEASE CASE

- 1 x C33 Frame
- 6 x Magnetic Struts
- 1 x C33 Photo Mural Kit
- 1 x RollEase Case
- 1 x Set of 2 Lights

22KG



CODE | **CLASS33RO**

CONTENTS |
C33 BASIC KIT IN A ROLLONE CASE

- 1 x C33 Frame
- 6 x Magnetic Struts
- 1 x C33 Photo Mural Kit
- 1 x RollOne Case
- 1 x Set of 2 Lights
- 1 x Counter Top

31KG



C33

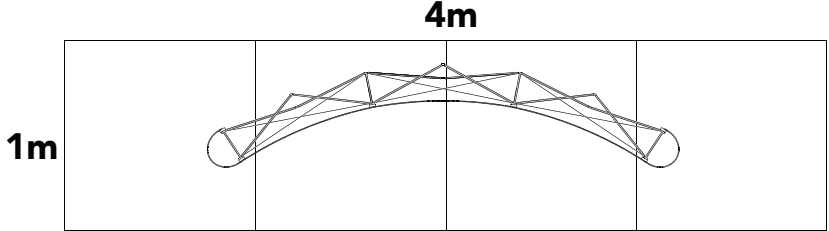

Assembled Dimensions
2.36m H x 2.485m W x 0.55m D

PREMIUM KITS WITH GRAPHICS



CODE | **CLASS33RP**

CONTENTS |
C33 BASIC KIT IN A ROLLPLUS 33 CASE

- 1 x C33 Frame
- 6 x Magnetic Struts
- 1 x RollPlus 33 Case
- 1 x Set of Graphics
- 1 x Set of 2 Lights

29KG



CODE | **CLASS33RE**

CONTENTS |
C33 BASIC KIT IN A ROLLEASE CASE

- 1 x C33 Frame
- 6 x Magnetic Struts
- 1 x RollEase Case
- 1 x Set of Graphics
- 1 x Set of 2 Lights

30KG



CODE | **CLASS33RO**

CONTENTS |
C33 BASIC KIT IN A ROLLONE CASE

- 1 x C33 Frame
- 6 x Magnetic Struts
- 1 x RollOne Case
- 1 x Set of Graphics with wrap
- 1 x Set of 2 Lights
- 1 x Counter Top

40KG

C34

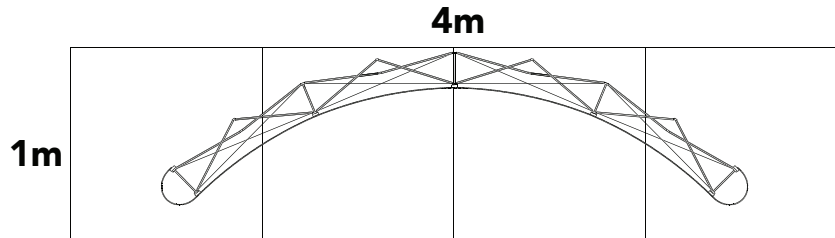

Assembled Dimensions
2.36m H x 3.05m W x 0.8m D

BASIC KITS



CODE | **CLASS34RP**

CONTENTS |

C34 BASIC KIT IN A ROLLPLUS 33 CASE

- 1 x C34 Frame
- 7 x Magnetic Struts
- 1 x C34 Photo Mural Kit
- 1 x RollPlus 33 Case

 **21KG**



CODE | **CLASS34RE**

CONTENTS |

C34 BASIC KIT IN A ROLLEASE CASE

- 1 x C34 Frame
- 7 x Magnetic Struts
- 1 x C34 Photo Mural Kit
- 1 x RollEase Case

 **22KG**



CODE | **CLASS34RO**

CONTENTS |

C34 BASIC KIT IN A ROLLEONE CASE

- 1 x C34 Frame
- 7 x Magnetic Struts
- 1 x C34 Photo Mural Kit
- 1 x RollOne Case

 **27KG**

C34

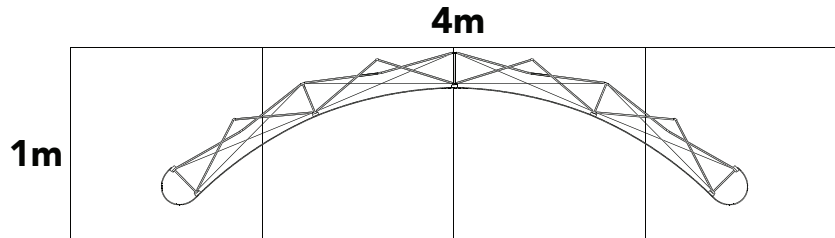

Assembled Dimensions
2.36m H x 3.05m W x 0.8m D

BASIC KITS WITH GRAPHICS



CODE | **CLASS34RPG**

CONTENTS |

**C34 BASIC KIT WITH GRAPHICS
IN A ROLLPLUS 33 CASE**

- 1 x C34 Frame
- 7 x Magnetic Struts
- 1 x RollPlus 33 Case
- 1 x Set of Graphics

KG 31KG



CODE | **CLASS34REG**

CONTENTS |

**C34 BASIC KIT WITH GRAPHICS
IN A ROLLEASE CASE**

- 1 x C34 Frame
- 7 x Magnetic Struts
- 1 x RollEase Case
- 1 x Set of Graphics

KG 32KG



CODE | **CLASS34ROG**

CONTENTS |

**C34 BASIC KIT WITH GRAPHICS
IN A ROLLONE CASE**

- 1 x C34 Frame
- 7 x Magnetic Struts
- 1 x RollOne Case
- 1 x Set of Graphics with Wrap

KG 38KG

C34

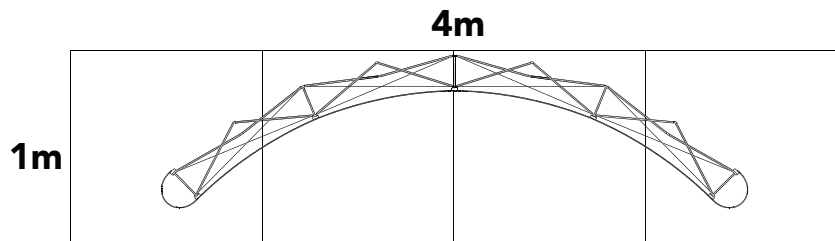

Assembled Dimensions
2.36m H x 3.05m W x 0.8m D

PREMIUM KITS



CODE | **CLASS34RP**

CONTENTS |
**C34 BASIC KIT IN A
ROLLPLUS 33 CASE**

- 1 x C34 Frame
- 7 x Magnetic Struts
- 1 x C34 Photo Mural Kit
- 1 x RollPlus 33 Case
- 1 x Set of 2 lights

 **23KG**



CODE | **CLASS34RE**

CONTENTS |
**C34 BASIC KIT IN A
ROLLEASE CASE**

- 1 x C34 Frame
- 7 x Magnetic Struts
- 1 x C34 Photo Mural Kit
- 1 x RollEase Case
- 1 x Set of 2 Lights

 **24KG**



CODE | **CLASS34RO**

CONTENTS |
**C34 BASIC KIT IN A
ROLLONE CASE**

- 1 x C34 Frame
- 7 x Magnetic Struts
- 1 x C34 Photo Mural Kit
- 1 x RollOne Case
- 1 x Set of 2 Lights
- 1 x Counter Top

 **33KG**

C34

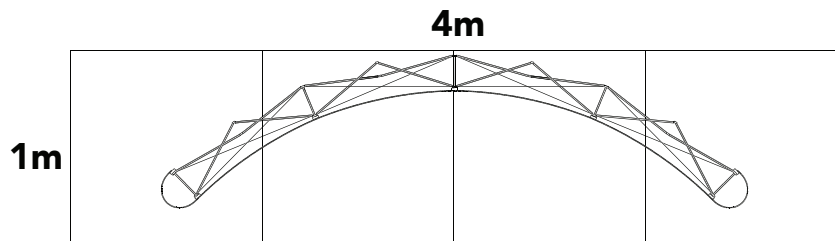

Assembled Dimensions
2.36m H x 3.05m W x 0.8m D

PREMIUM KITS WITH GRAPHICS



CODE | **CLASS34RP**

CONTENTS |

C34 BASIC KIT IN A ROLLPLUS 33 CASE

- 1 x C34 Frame
- 7 x Magnetic Struts
- 1 x RollPlus 33 Case
- 1 x Set of Graphics
- 1 x Set of 2 Lights

 **33KG**



CODE | **CLASS34RE**

CONTENTS |

C34 BASIC KIT IN A ROLLEASE CASE

- 1 x C34 Frame
- 7 x Magnetic Struts
- 1 x RollEase Case
- 1 x Set of Graphics
- 1 x Set of 2 Lights

 **24KG**



CODE | **CLASS34RO**

CONTENTS |

C34 BASIC KIT IN A ROLLONE CASE

- 1 x C34 Frame
- 7 x Magnetic Struts
- 1 x RollOne Case
- 1 x Set of Graphics with wrap
- 1 x Set of 2 Lights
- 1 x Counter Top

 **44KG**

CLASSIC SERIES ACCESSORIES

Monitor Mount



CMMKWFB

Classic Small Monitor mount kit - up to 24" - with Front Bracket

CMMKWBB

Classic Small Monitor mount kit - up to 24" - with Back Bracket

CMMKWOB

Classic Small Monitor mount kit - up to 24" - without Bracket

Max weight: 8kg

Floating Product Display Shelf

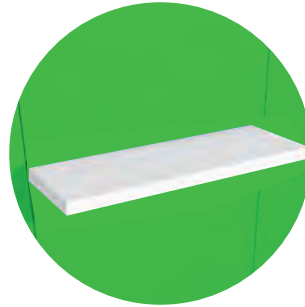

Available in:

 White

CPSKWFB

Classic Product Display Shelf kit with Front Bracket

CPSKWOB

Classic Product Display Shelf without Bracket

Max weight per shelf: 7kg

Max Weight per frame: 15kg

A4 Modular Literature Holder



CLHKA4WFB

Classic Lit. Holder kit - A4 - with Front Bracket

CLHKA4WBB

Classic Lit. Holder kit - A4 - with Back Bracket

CLHKA4WOB

Classic Lit. Holder kit - A4 - without Bracket

CLASSIC SERIES

Classic Accessories

PRODUCT CODE	DESCRIPTION
LFH-E	Premium Halogen Light Chord
LRL017	Set of 2 Premium Halogen Lights, Electrostrut and International Plug Set in a Tuxedo Box
LRL018	Set of 2 Premium Halogen Lights, Electrostrut and International Plug Set in a Light Tray
LRL016	Set of 3 Premium Halogen Lights, Electrostrut and International Plug Set in a Tuxedo Box
LEDW-E	Single LED light
LEDW002	Set of 2 LED lights, ElectroStrut and International Plug Set in a Tuxedo Box
LEDW005	Set of 2 LED lights, ElectroStrut and International Plug Set in a Light Tray
LEDW003	Set of 3 LED lights, ElectroStrut and International Plug Set in a Tuxedo Box
MCUPOLE	Extendable Curtain Pole
CMMKWFB	Classic Small Monitor mount kit - up to 24" - with Front Bracket
CMMKWBB	Classic Small Monitor mount kit - up to 24" - with Back Bracket
CMMKWOB	Classic Small Monitor mount kit - up to 24" - without Bracket
CPSKWFB	Classic Product Display Shelf kit with Front Bracket
CPSKWOB	Classic Product Display Shelf kit without Bracket
CLHKA4WFB	Classic Lit. Holder kit - A4 - with Front Bracket
CLHKA4WBB	Classic Lit. Holder kit - A4 - with Back Bracket
CLHKA4WOB	Classic Lit. Holder kit - A4 - without Bracket

Cases

PRODUCT CODE	DESCRIPTION
CRO02	RollOne Case
CRP33	RollPlus 33 Case
CCY14	14" Cylindrical Case
CRE	RollEase Case
CROPCT	RollOne Premium Counter Top
CROBSCT	RollOne Black Blotter
CRP33SCT	RollPlus 33 Insert Countertop - Wood Finish 3mm
CRP33PCT	RollPlus 33 External Counter Top - Oversized in a Carry Bag

*extra cases may be required for graphics/accessories.

Classic Frames and Components

PRODUCT CODE	DESCRIPTION
C11	1x1 Classic Frame in a Nylon Bag
C12	1x2 Classic Frame in a Nylon Bag
C13	1x3 Classic Frame in a Nylon Bag
MSC1	One Quad High Connected Strut
MSC125	One and a Quarter Quad High Connected Strut
C22	2x2 Classic Frame in a Nylon Bag
C23	2x3 Classic Frame in a Nylon Bag
MSC2	Two Quad High Connected Strut
C31	3x1 Classic Frame in a Nylon Bag
C32	3x2 Classic Frame in a Nylon Bag
C33	3x3 Classic Frame in a Nylon Bag
C34	3x4 Classic Frame in a Nylon Bag
C38	3x8 Classic Frame in a Nylon Bag
MSC3	Three Quad High Connected Strut
MSC3H	Three Quad High Hinged Connected Strut
C43	4 x 3 Classic Frame in a Nylon Bag
MSC4	Four Quad High Connected Strut
MSC4H	Four Quad High Hinged Connected Strut

Classic Photo Kits

PRODUCT CODE	DESCRIPTION
PKC001	Photo Kit - for 1 C33 Classic Frame
PKC002	Photo Kit - for 5 C33 Classic Frame
PKC003	Photo Kit - for 1 C34 Classic Frame
PKC004	Photo Kit - for 5 C34 Classic Frame
GSCLT	Classic Panel Top Stiffener
GSCLB	Classic Panel Bottom Stiffener
GSSRT	Small Round End Cap Top Stiffener
GSSRB	Small Round End Cap Bottom Stiffener
YGSCLRT	Classic Large Round End Cap Top Stiffener
YGSCLRB	Classic Large Round End Cap Bottom Stiffener
GSSFT	Small Flat End Cap Top Stiffener
GSSFB	Small Flat End Cap Bottom Stiffener
GSCLTB	Classic Back Panel Top Stiffener
GSCLBB	Classic Back Panel Bottom Stiffener
GTDS165	Tape - 50m Roll of 25mm Double Sided PV1
GTDS33	Tape - 10m Roll of 25mm Double Sided PV1
GTMA100	100'/30m Roll of A Magnetic Tape
GTMB100	100'/30m Roll of 12.5mm B Magnetic Tape
GTWH25	Tape - Hinging 25m Roll of 38mm White
GTBH25	Tape - Hinging 25m Roll of 38mm Black
VGTVH75-3	Velcro Tape Hook, 10mm x 25m Roll
VGTVL75-3	Velcro Tape Loop, 10mm x 25m Roll
VGTVH75	Velcro Tape Loop, 25mm x 25m Roll
VGTVL75	Velcro Tape Loop, 25mm x 25m Roll

*extra cases may be required for graphics/accessories.

NOTES

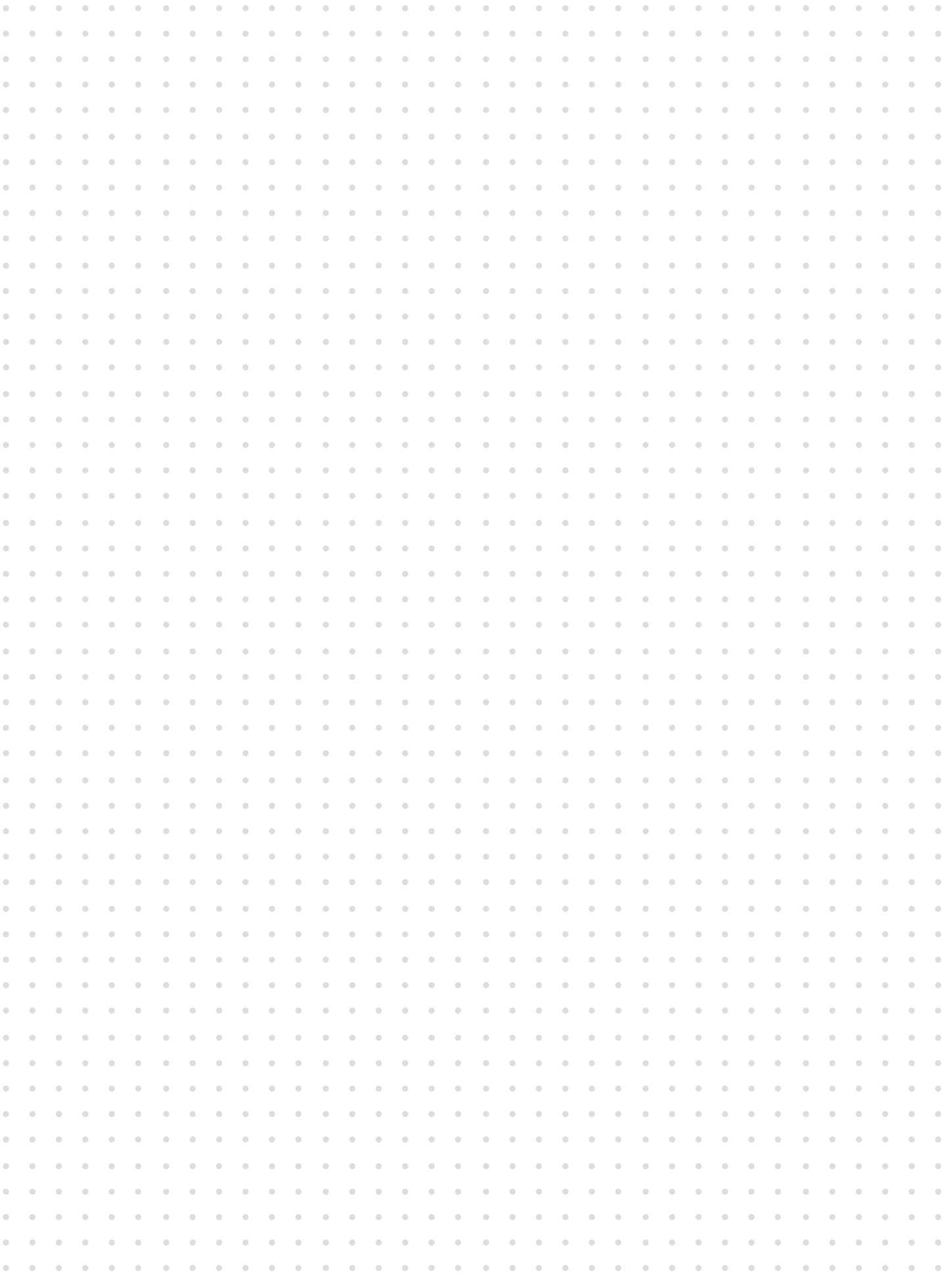



INSTAND[®] PLUS



P31

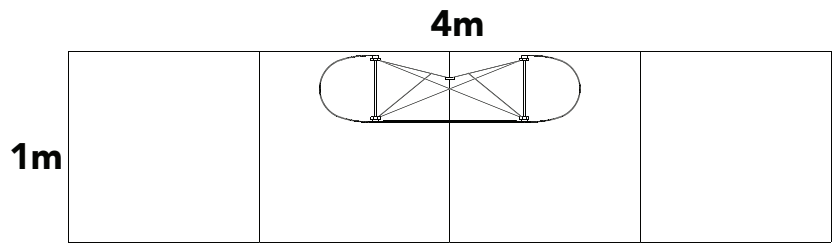

Assembled Dimensions
2.36m H x 1.37m W x 0.35m D

BASIC KITS



CODE | **PLUS31RP**

CONTENTS |
P31 BASIC KIT IN A ROLLPLUS 33 CASE

- 1 x P31 Frame
- 4 x Magnetic Struts
- 1 x P31 Photo Mural Kit
- 1 x RollPlus 33 Case

16KG



CODE | **PLUS31RE**

CONTENTS |
P31 BASIC KIT IN A ROLLEASE CASE

- 1 x P31 Frame
- 4 x Magnetic Struts
- 1 x P31 Photo Mural Kit
- 1 x RollEase Case

17KG



CODE | **PLUS31RO**

CONTENTS |
P31 BASIC KIT IN A ROLLEONE CASE

- 1 x P31 Frame
- 4 x Magnetic Struts
- 1 x P31 Photo Mural Kit
- 1 x RollOne Case

22KG



P31

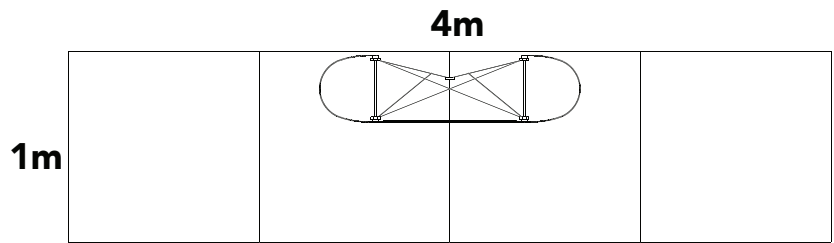

Assembled Dimensions
2.36m H x 1.37m W x 0.35m D

BASIC KITS WITH GRAPHICS



CODE **PLUS31RP**

CONTENTS |
P31 BASIC KIT WITH GRAPHICS
IN A ROLLPLUS 33 CASE

- 1 x P31 Frame
- 4 x Magnetic Struts
- 1 x RollPlus 33 Case
- 1 x Set of Graphics

21KG



CODE | **PLUS31RE**

CONTENTS |
P31 BASIC KIT WITH GRAPHICS
IN A ROLLEASE CASE

- 1 x P31 Frame
- 4 x Magnetic Struts
- 1 x RollEase Case
- 1 x Set of Graphics

22KG



CODE | **PLUS31RO**

CONTENTS |
P31 BASIC KIT WITH GRAPHICS
IN A ROLLONE CASE

- 1 x P31 Frame
- 4 x Magnetic Struts
- 1 x RollOne Case
- 1 x Set of Graphics with Wrap

27KG



P31

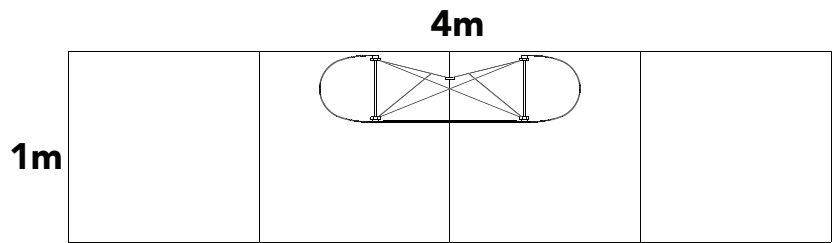

Assembled Dimensions
2.36m H x 1.37m W x 0.35m D

PREMIUM KITS



CODE | PLUS31RP

CONTENTS | P31 BASIC KIT IN A ROLLPLUS 33 CASE

- 1 x P31 Frame
- 4 x Magnetic Struts
- 1 x P31 Photo Mural Kit
- 1 x set of 2 lights
- 1 x RollPlus 33 Case

16KG



PLUS31RE

CONTENTS | P31 BASIC KIT IN A ROLLEASE CASE

- 1 x P31 Frame
- 4 x Magnetic Struts
- 1 x P31 Photo Mural Kit
- 1 x set of 2 lights
- 1 x RollEase Case

17KG



CODE | PLUS31RO

CONTENTS | P31 BASIC KIT IN A ROLLEONE CASE

- 1 x P31 Frame
- 4 x Magnetic Struts
- 1 x P31 Photo Mural Kit
- 1 x set of 2 lights
- 1 x Counter Top
- 1 x RollOne Case

22KG



P31

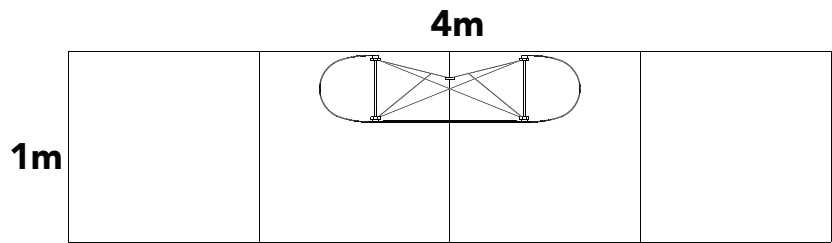

Assembled Dimensions
2.36m H x 1.37m W x 0.35m D

PREMIUM KITS WITH GRAPHICS



CODE | **PLUS31RP**

CONTENTS |
**P31 BASIC KIT WITH GRAPHICS
 IN A ROLLPLUS 33 CASE**

- 1 x P31 Frame
- 4 x Magnetic Struts
- 1 x set of 2 lights
- 1 x RollPlus 33 Case
- 1 x Set of Graphics

KG 21KG



CODE | **PLUS31RE**

CONTENTS |
**P31 BASIC KIT WITH GRAPHICS
 IN A ROLLEASE CASE**

- 1 x P31 Frame
- 4 x Magnetic Struts
- 1 x set of 2 lights
- 1 x RollEase Case
- 1 x Set of Graphics

KG 22KG



CODE | **PLUS31RO**

CONTENTS |
**P31 BASIC KIT WITH GRAPHICS
 IN A ROLLONE CASE**

- 1 x P31 Frame
- 4 x Magnetic Struts
- 1 x set of 2 lights
- 1 x Counter Top
- 1 x RollOne Case
- 1 x Set of Graphics with Wrap

KG 27KG



P32

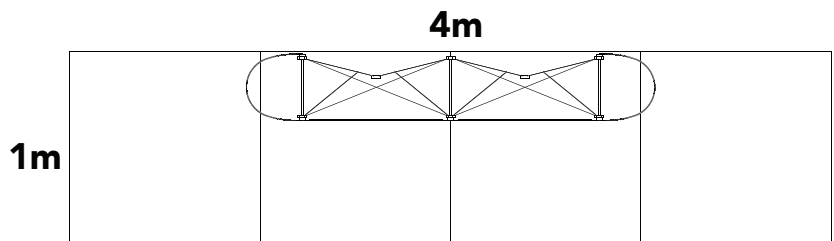

Assembled Dimensions
2.36m H x 2.15m W x 0.35m D

BASIC KITS



CODE | **PLUS32RP**

CONTENTS |
**P32 BASIC KIT IN A
ROLLPLUS 33 CASE**

- 1 x P32 Frame
- 5 x Magnetic Struts
- 1 x P32 Photo Mural Kit
- 1 x RollPlus 33 Case

19KG



CODE | **PLUS32RE**

CONTENTS |
**P32 BASIC KIT IN A
ROLLEASE CASE**

- 1 x P32 Frame
- 5 x Magnetic Struts
- 1 x P32 Photo Mural Kit
- 1 x RollEase Case

23KG



CODE | **PLUS32RO**

CONTENTS |
**P32 BASIC KIT IN A
ROLLEONE CASE**

- 1 x P32 Frame
- 5 x Magnetic Struts
- 1 x P32 Photo Mural Kit
- 1 x RollOne Case

25KG



P32

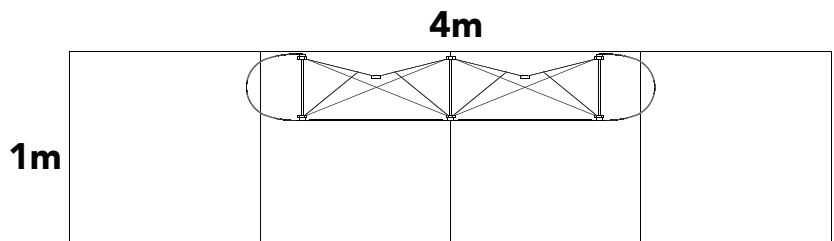

Assembled Dimensions
2.36m H x 2.15m W x 0.35m D

BASIC KITS WITH GRAPHICS



CODE | **PLUS32RP**

CONTENTS |
**P32 BASIC KIT WITH GRAPHICS
IN A ROLLPLUS 33 CASE**

- 1 x P32 Frame
- 5 x Magnetic Struts
- 1 x RollPlus 33 Case
- 1 x Set of Graphics

24KG



CODE | **PLUS32RE**

CONTENTS |
**P31 BASIC KIT WITH GRAPHICS
IN A ROLLEASE CASE**

- 1 x P32 Frame
- 5 x Magnetic Struts
- 1 x RollEase Case
- 1 x Set of Graphics

28KG



CODE | **PLUS32RO**

CONTENTS |
**P32 BASIC KIT WITH GRAPHICS
IN A ROLLONE CASE**

- 1 x P32 Frame
- 5 x Magnetic Struts
- 1 x RollOne Case
- 1 x Set of Graphics with Wrap

30KG



P32

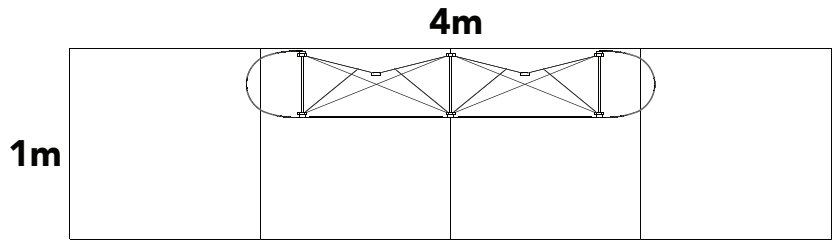

Assembled Dimensions
2.36m H x 2.15m W x 0.35m D

PREMIUM KITS



CODE | **PLUS32RP**

CONTENTS |
P32 BASIC KIT IN A ROLLPLUS 33 CASE

- 1 x P32 Frame
- 5 x Magnetic Struts
- 1 x P32 Photo Mural Kit
- 1 x set of 2 lights
- 1 x RollPlus 33 Case

19KG



CODE | **PLUS32RE**

CONTENTS |
P32 BASIC KIT IN A ROLLEASE CASE

- 1 x P32 Frame
- 5 x Magnetic Struts
- 1 x P32 Photo Mural Kit
- 1 x set of 2 lights
- 1 x RollEase Case

23KG



CODE | **PLUS32RO**

CONTENTS |
P32 BASIC KIT IN A ROLLEONE CASE

- 1 x P32 Frame
- 5 x Magnetic Struts
- 1 x P32 Photo Mural Kit
- 1 x set of 2 lights
- 1 x Counter Top
- 1 x RollOne Case

25KG



P32

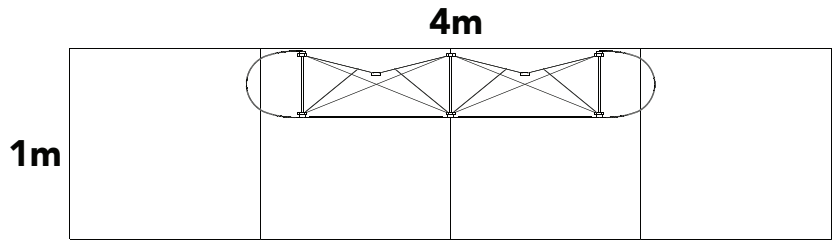

Assembled Dimensions
2.36m H x 2.15m W x 0.35m D

PREMIUM KITS WITH GRAPHICS



CODE | **PLUS32RP**

CONTENTS |
**P32 BASIC KIT WITH GRAPHICS
 IN A ROLLPLUS 33 CASE**

- 1 x P32 Frame
- 5 x Magnetic Struts
- 1 x set of 2 lights
- 1 x RollPlus 33 Case
- 1 x Set of Graphics

24KG



CODE | **PLUS32RE**

CONTENTS |
**P31 BASIC KIT WITH GRAPHICS
 IN A ROLLEASE CASE**

- 1 x P32 Frame
- 5 x Magnetic Struts
- 1 x set of 2 lights
- 1 x RollEase Case
- 1 x Set of Graphics

28KG



CODE | **PLUS32RO**

CONTENTS |
**P32 BASIC KIT WITH GRAPHICS
 IN A ROLLONE CASE**

- 1 x P32 Frame
- 5 x Magnetic Struts
- 1 x set of 2 lights
- 1 x Counter Top
- 1 x RollOne Case
- 1 x Set of Graphics with Wrap

30KG

P33

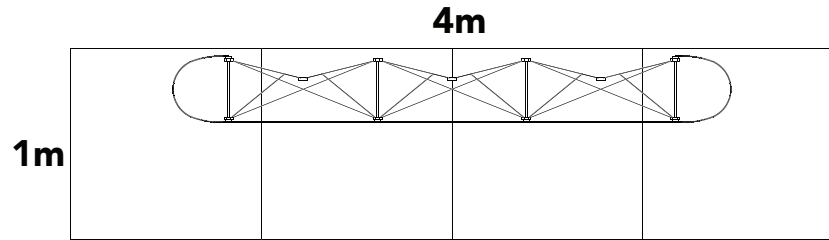

Assembled Dimensions
2.36m H x 2.93m W x 0.35m D

BASIC KITS



CODE | **PLUS33RP**

CONTENTS |
P33 BASIC KIT IN A ROLLPLUS 33 CASE

- 1 x P33 Frame
- 6 x Magnetic Struts
- 1 x P33 Photo Mural Kit
- 1 x RollPlus 33 Case

22KG



CODE | **PLUS33RE**

CONTENTS |
P33 BASIC KIT IN A ROLLEASE CASE

- 1 x P33 Frame
- 6 x Magnetic Struts
- 1 x P33 Photo Mural Kit
- 1 x RollEase Case

23KG



CODE | **PLUS33RO**

CONTENTS |
P33 BASIC KIT IN A ROLLEONE CASE

- 1 x P33 Frame
- 6 x Magnetic Struts
- 1 x P33 Photo Mural Kit
- 1 x RollOne Case

28KG

P33

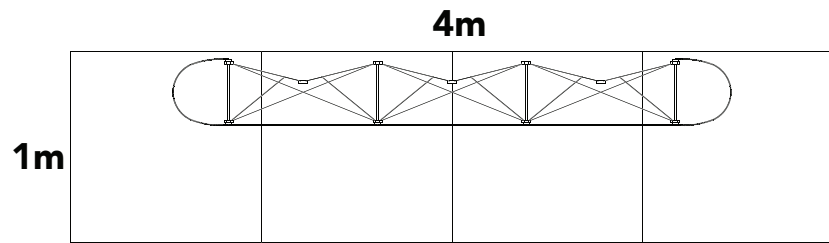

Assembled Dimensions
2.36m H x 2.93m W x 0.35m D

BASIC KITS WITH GRAPHICS



CODE | **PLUS31RP**

CONTENTS |
**P33 BASIC KIT WITH GRAPHICS
IN A ROLLPLUS 33 CASE**

- 1 x P33 Frame
- 6 x Magnetic Struts
- 1 x RollPlus 33 Case
- 1 x Set of Graphics

27KG



CODE | **PLUS33RE**

CONTENTS |
**P33 BASIC KIT WITH GRAPHICS
IN A ROLLEASE CASE**

- 1 x P33 Frame
- 6 x Magnetic Struts
- 1 x RollEase Case
- 1 x Set of Graphics

28KG



CODE | **PLUS33RO**

CONTENTS |
**P33 BASIC KIT WITH GRAPHICS
IN A ROLLONE CASE**

- 1 x P33 Frame
- 6 x Magnetic Struts
- 1 x RollOne Case
- 1 x Set of Graphics with Wrap

33KG

P33

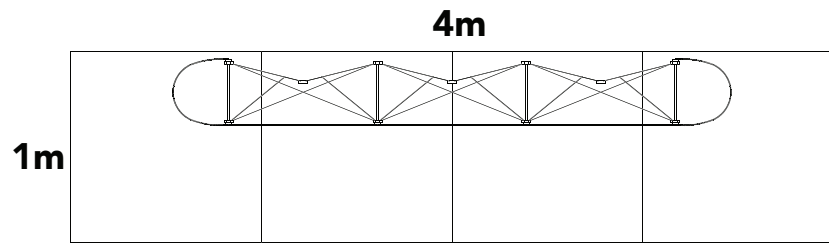

Assembled Dimensions
2.36m H x 2.93m W x 0.35m D

PREMIUM KITS



CODE | **PLUS33RP**

CONTENTS |
P33 BASIC KIT IN A ROLLPLUS 33 CASE

- 1 x P33 Frame
- 6 x Magnetic Struts
- 1 x P33 Photo Mural Kit
- 1 x set of 2 lights
- 1 x RollPlus 33 Case

22KG



CODE | **PLUS33RE**

CONTENTS |
P33 BASIC KIT IN A ROLLEASE CASE

- 1 x P33 Frame
- 6 x Magnetic Struts
- 1 x P33 Photo Mural Kit
- 1 x set of 2 lights
- 1 x RollEase Case

23KG



CODE | **PLUS33RO**

CONTENTS |
P33 BASIC KIT IN A ROLLEONE CASE

- 1 x P33 Frame
- 6 x Magnetic Struts
- 1 x P33 Photo Mural Kit
- 1 x set of 2 lights
- 1 x Counter Top
- 1 x RollOne Case

28KG

P33

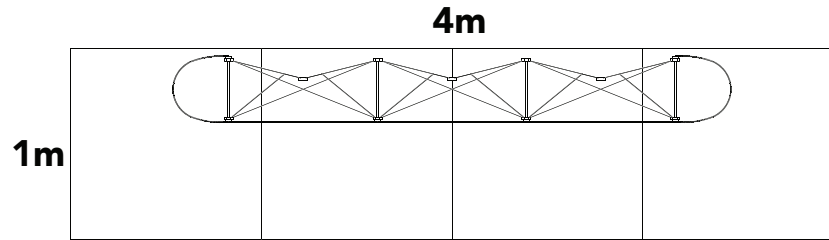

Assembled Dimensions
2.36m H x 2.93m W x 0.35m D

PREMIUM KITS WITH GRAPHICS



CODE | **PLUS31RP**

CONTENTS |
**P33 BASIC KIT WITH GRAPHICS
IN A ROLLPLUS 33 CASE**

- 1 x P33 Frame
- 6 x Magnetic Struts
- 1 x set of 2 lights
- 1 x RollPlus 33 Case
- 1 x Set of Graphics

27KG



CODE | **PLUS33RE**

CONTENTS |
**P33 BASIC KIT WITH GRAPHICS
IN A ROLLEASE CASE**

- 1 x P33 Frame
- 6 x Magnetic Struts
- 1 x set of 2 lights
- 1 x RollEase Case
- 1 x Set of Graphics

28KG



CODE | **PLUS33RO**

CONTENTS |
**P33 BASIC KIT WITH GRAPHICS
IN A ROLLONE CASE**

- 1 x P33 Frame
- 6 x Magnetic Struts
- 1 x set of 2 lights
- 1 x Counter Top
- 1 x RollOne Case
- 1 x Set of Graphics with Wrap

33KG

P34

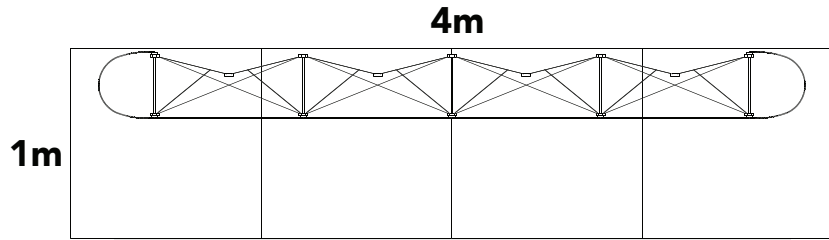

Assembled Dimensions
2.36m H x 2.7m W x 0.35m D

BASIC KITS



CODE | **PLUS34RP**

CONTENTS |
**P34 BASIC KIT IN A
ROLLPLUS 33 CASE**

- 1 x P34 Frame
- 7 x Magnetic Struts
- 1 x P34 Photo Mural Kit
- 1 x RollPlus 33 Case

 **24.5KG**



CODE | **PLUS34RE**

CONTENTS |
**P34 BASIC KIT IN A
ROLLEASE CASE**

- 1 x P34 Frame
- 7 x Magnetic Struts
- 1 x P34 Photo Mural Kit
- 1 x RollEase Case

 **26KG**



CODE | **PLUS34RO**

CONTENTS |
**P34 BASIC KIT IN A
ROLLEONE CASE**

- 1 x P34 Frame
- 7 x Magnetic Struts
- 1 x P34 Photo Mural Kit
- 1 x RollOne Case

 **31KG**

P34

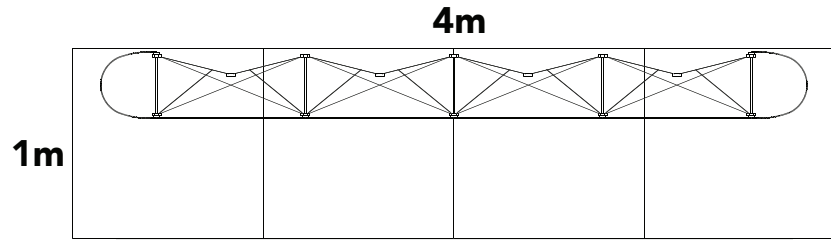

Assembled Dimensions
2.36m H x 2.7m W x 0.35m D

BASIC KITS WITH GRAPHICS



CODE | **PLUS34RP**

CONTENTS |
**P34 BASIC KIT WITH GRAPHICS
IN A ROLLPLUS 33 CASE**

- 1 x P34 Frame
- 7 x Magnetic Struts
- 1 x RollPlus 33 Case
- 1 x Set of Graphics

KG 29.5KG



CODE | **PLUS34RE**

CONTENTS |
**P34 BASIC KIT WITH GRAPHICS
IN A ROLLEASE CASE**

- 1 x P34 Frame
- 7 x Magnetic Struts
- 1 x RollEase Case
- 1 x Set of Graphics

KG 31KG



CODE | **PLUS34RO**

CONTENTS |
**P34 BASIC KIT WITH GRAPHICS
IN A ROLLONE CASE**

- 1 x P34 Frame
- 7 x Magnetic Struts
- 1 x RollOne Case
- 1 x Set of Graphics with Wrap

KG 36KG

P34

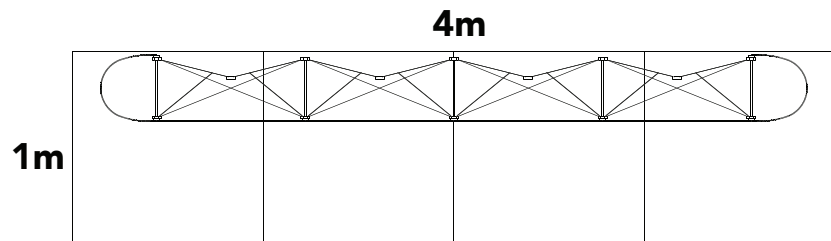

Assembled Dimensions
2.36m H x 2.7m W x 0.35m D

PREMIUM KITS



CODE | **PLUS34RP**

CONTENTS |
**P34 BASIC KIT IN A
ROLLPLUS 33 CASE**

- 1 x P34 Frame
- 7 x Magnetic Struts
- 1 x P34 Photo Mural Kit
- 1 x set of 2 lights
- 1 x RollPlus 33 Case

 **24.5KG**



CODE | **PLUS34RE**

CONTENTS |
**P34 BASIC KIT IN A
ROLLEASE CASE**

- 1 x P34 Frame
- 7 x Magnetic Struts
- 1 x P34 Photo Mural Kit
- 1 x set of 2 lights
- 1 x RollEase Case

 **26KG**



PLUS34RO

CONTENTS |
**P34 BASIC KIT IN A
ROLLEONE CASE**

- 1 x P34 Frame
- 7 x Magnetic Struts
- 1 x P34 Photo Mural Kit
- 1 x set of 2 lights
- 1 x Counter Top
- 1 x RollOne Case

 **31KG**

P34

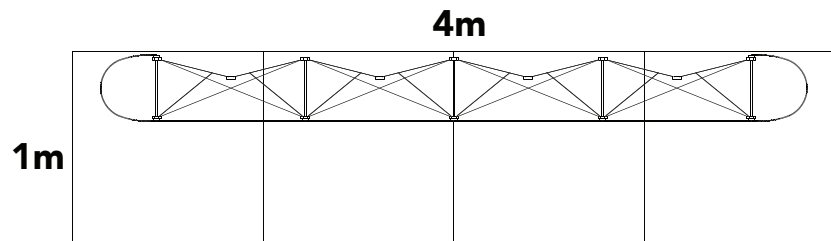

Assembled Dimensions
2.36m H x 2.7m W x 0.35m D

PREMIUM KITS WITH GRAPHICS



CODE | **PLUS34RP**

CONTENTS |
**P34 BASIC KIT WITH GRAPHICS
IN A ROLLPLUS 33 CASE**

- 1 x P34 Frame
- 7 x Magnetic Struts
- 1 x set of 2 lights
- 1 x RollPlus 33 Case
- 1 x Set of Graphics

29.5KG



CODE | **PLUS34RE**

CONTENTS |
**P34 BASIC KIT WITH GRAPHICS
IN A ROLLEASE CASE**

- 1 x P34 Frame
- 7 x Magnetic Struts
- 1 x set of 2 lights
- 1 x RollEase Case
- 1 x Set of Graphics

31KG



CODE | **PLUS34RO**

CONTENTS |
**P34 BASIC KIT WITH GRAPHICS
IN A ROLLONE CASE**

- 1 x P34 Frame
- 7 x Magnetic Struts
- 1 x set of 2 lights
- 1 x Counter Top
- 1 x RollOne Case
- 1 x Set of Graphics with Wrap

36KG

PLUS SERIES ACCESSORIES

Monitor Mount



CDL014

CDL014 Plus Monitor Mount - up to 60"
Max weight 30kg

PMMKWB

Plus Small Monitor mount kit - up to 24" with Bracket

PMMKWOB

Plus Small Monitor mount kit - up to 24" without Bracket
Max weight 8kg

Floating Product Display Shelf



Available in:

○ White

PFPSKWBWH

Plus Floating Product Shelf kit with Bracket - white

PFPSKWOBWH

Plus Floating Product Shelf kit without Bracket - white

Do not use external shelves on
Plus backwalls without return walls.
Max weight per shelf - 7kg | Max Weight per frame - 15kg

A4 Modular Literature Holder



PLHKA4WB

Plus Lit. Holder kit - A4 - with Bracket

PLHKA4WOB

Plus Lit. Holder kit - A4 - without Bracket

PLUS SERIES

Plus Accessories

PRODUCT CODE	DESCRIPTION
LFH-E	Premium Halogen Light Chord
LRL017	Set of 2 Premium Halogen Lights, Electrostrut and International Plug Set in a Tuxedo Box
LRL018	Set of 2 Premium Halogen Lights, Electrostrut and International Plug Set in a Light Tray
LRL016	Set of 3 Premium Halogen Lights, Electrostrut and International Plug Set in a Tuxedo Box
LEDW-E	Single LED light
LEDW002	Set of 2 LED lights, ElectroStrut and International Plug Set in a Tuxedo Box
LEDW005	Set of 2 LED lights, ElectroStrut and International Plug Set in a Light Tray
LEDW003	Set of 3 LED lights, ElectroStrut and International Plug Set in a Tuxedo Box
MCUPOLE	Extendable Curtain Pole
MCSCPP	Plus to Plus Connecting Scissors
MCSCPP35	90 Degree Connecting Scissors
CDL014	Plus Monitor Mount Kit in a RollPlus Case
PMMKWOB	Plus Small Monitor mount kit - up to 24" with Bracket
PFPSKW BWH	Plus Small Monitor mount kit - up to 24" without Bracket
PFPSKW BBLK	Plus Floating Product Shelf kit with Bracket - white
PFPSKWOB BWH	Plus Floating Product Shelf kit with Bracket - black
PFPSKWOB BBLK	Plus Floating Product Shelf kit without Bracket - white
PTMKWB	Plus Floating Product Shelf kit without Bracket - black
PLHKA4WOB	Plus Lit. Holder kit - A4 - with Bracket
CTMKWOB	Plus Lit. Holder kit - A4 - without Bracket
SE0009	One Quad Delux ShowCase Kit for Int. Shelves
SE0008	One Quad ShowCase Kit for Int. Shelves
SSPSAP	Adjustable Acrylic Shelf for ShowCase

*extra cases may be required for graphics/accessories.

Plus Frames and Components

PRODUCT CODE	DESCRIPTION
P11	1x1 Plus Frame in a Nylon Bag
P12	1x2 Plus Frame in a Nylon Bag
P11E	1x1 Extended Quad Plus Frame in a Nylon Bag
P12E	1x2 Extended Quad Plus Frame in a Nylon Bag
MSC1	One Quad High Connected Strut
MSE1	One Quad High Extended Strut
P21	2x1 Plus Frame in a Nylon Bag
P22	2x2 Plus Frame in a Nylon Bag
P23	2x3 Plus Frame in a Nylon Bag
MSC2	Two Quad High Connected Strut
P31	3x1 Plus Frame in a Nylon Bag
P31M	3x1 Plus Manual Lock Frame in a Nylon Bag
P32	3x2 Plus Frame in a Nylon Bag
P32M	3x2 Plus Manual Lock Frame in a Nylon Bag
P33	3x3 Plus Frame in a Nylon Bag
P33M	3x3 Plus Manual Lock Frame in a Nylon Bag
P34	3x4 Plus Frame in a Nylon Bag
P35	3x5 Plus Frame in a Nylon Bag
MSC3	Three Quad High Connected Strut
MSC3H	Three Quad High Hinged Connected Strut
P41	4 x 1 Plus Frame in a Nylon Bag
P42	4 x 2 Plus Frame in a Nylon Bag
MSC4	Four Quad High Connected Strut
MSC4H	Four Quad High Hinged Connected Strut
P51	5 x 1 Plus Frame in a Nylon Bag
MSC5	Five Quad High Connected Strut
MSC5H	Five Quad High Hinged Connected Strut

Plus Photo Kits

PRODUCT CODE	DESCRIPTION
PKC001	Photo Kit - for 1 C33 Classic Frame
PKC002	Photo Kit - for 5 C33 Classic Frame
PKC003	Photo Kit - for 1 C34 Classic Frame
PKC004	Photo Kit - for 5 C34 Classic Frame
GSCLT	Classic Panel Top Stiffener
GSCLB	Classic Panel Bottom Stiffener
GSSRT	Small Round End Cap Top Stiffener
GSSRB	Small Round End Cap Bottom Stiffener
YGSCLR	Classic Large Round End Cap Top Stiffener
YGSCLRB	Classic Large Round End Cap Bottom Stiffener
GSSFT	Small Flat End Cap Top Stiffener
GSSFB	Small Flat End Cap Bottom Stiffener
GSCLTB	Classic Back Panel Top Stiffener
GSCLTB	Classic Back Panel Bottom Stiffener
GTDS165	Tape - 50m Roll of 25mm Double Sided PV1
GTDS33	Tape - 10m Roll of 25mm Double Sided PV1
GTMA100	100'/30m Roll of A Magnetic Tape
GTMB100	100'/30m Roll of 12.5mm B Magnetic Tape
GTWH25	Tape - Hinging 25m Roll of 38mm White
GTBH25	Tape - Hinging 25m Roll of 38mm Black
VGTVH75-3	Velcro Tape Hook, 10mm x 25m Roll
VGTVL75-3	Velcro Tape Loop, 10mm x 25m Roll
VGTVH75	Velcro Tape Loop, 25mm x 25m Roll
VGTVL75	Velcro Tape Loop, 25mm x 25m Roll

*extra cases may be required for graphics/accessories.

NOTES

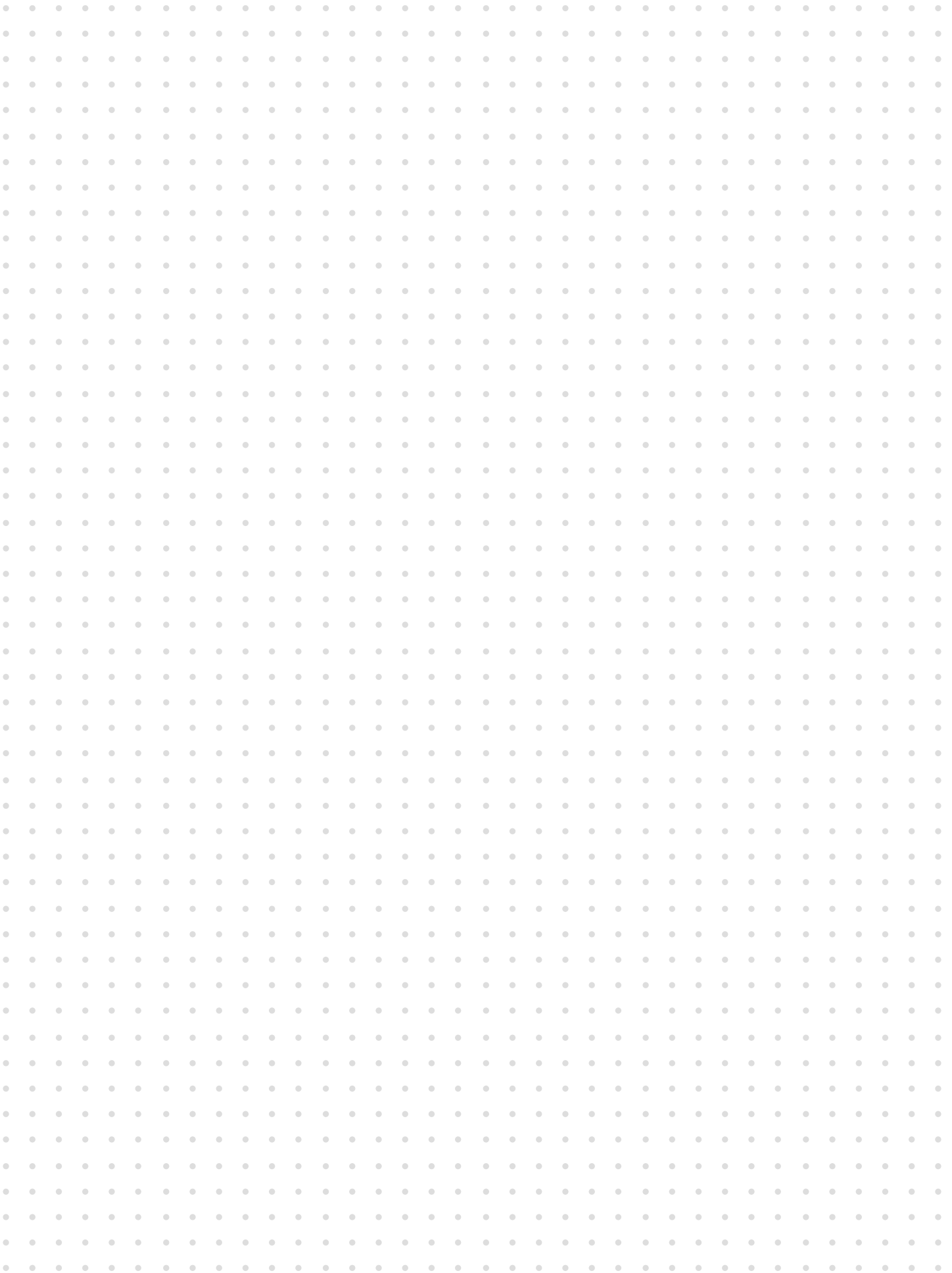



INSTAND[®] COMBI

C01

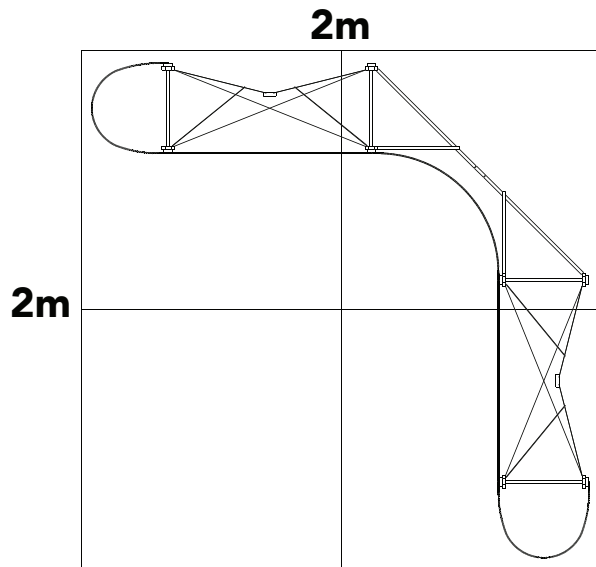

Assembled Dimensions
2.36m H x 1.65m W x 1.65m D

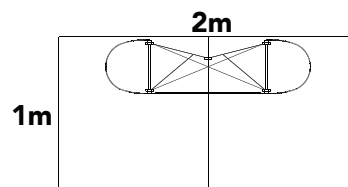
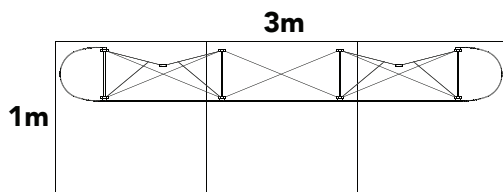

CODE | **COMBI01**

CONTENTS |

3 IN 1 KIT - P31/P31

- 2 x P31 Frame
- 6 x Magnetic Struts
- 2 x Plus to Plus Connecting Scissors
- 2 x 90 Degree Connecting Scissors
- 1 x Photo Mural Kit
- 1 x RollOne Case

 **26KG**

CODE | **COMBI01G**

CONTENTS |

**3 IN 1 KIT - P31/P31
WITH GRAPHICS**

- 2 x P31 Frame
- 6 x Magnetic Struts
- 2 x Plus to Plus Connecting Scissors
- 2 x 90 Degree Connecting Scissors
- 1 x RollOne Case
- 1 x Set of Graphics

 **28KG**

C02



2m

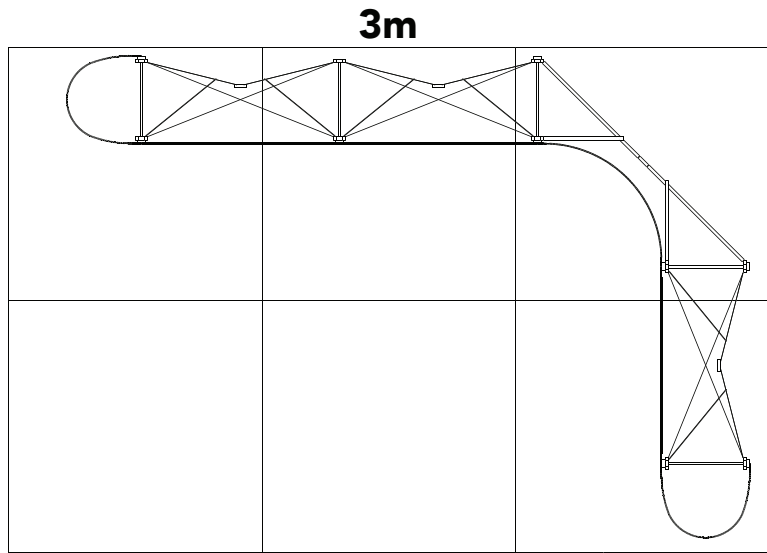

Assembled Dimensions
2.36m H x 2.43m W x 1.65m D

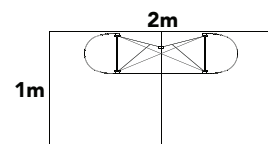
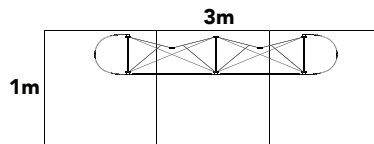
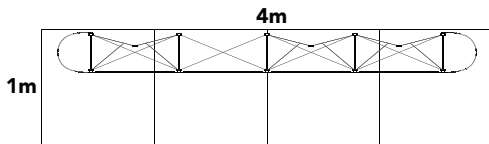

CODE | COMBI02

CONTENTS |

3 IN 1 KIT - P31/P32

- 1 x P31 Frame
- 1 x P32 Frame
- 7 x Magnetic Struts
- 2 x Plus to Plus Connecting Scissors
- 2 x 90 Degree Connecting Scissors
- 1 x Photo Mural Kit
- 1 x RollOne Case

29KG

CODE | COMBI02G

CONTENTS |

3 IN 1 KIT - P31/P32 WITH GRAPHICS

- 1 x P31 Frame
- 1 x P32 Frame
- 7 x Magnetic Struts
- 2 x Plus to Plus Connecting Scissors
- 2 x 90 Degree Connecting Scissors
- 1 x RollOne Case
- 1 x Set of Graphics

31KG

C03

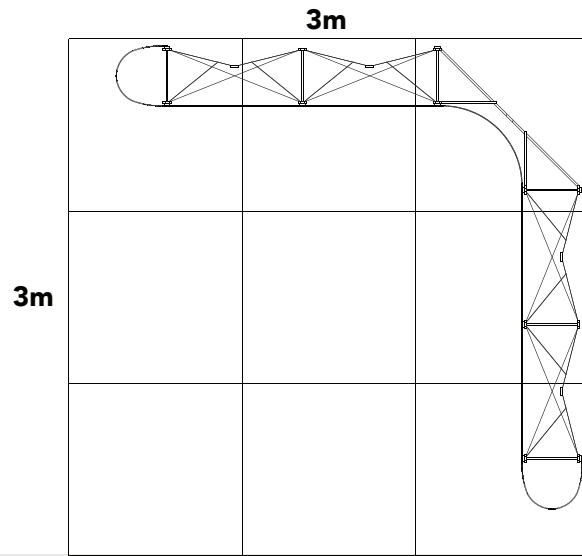

Assembled Dimensions
2.36m H x 2.43m W x 2.43m D

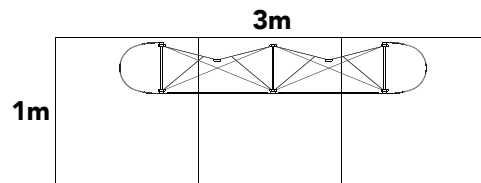
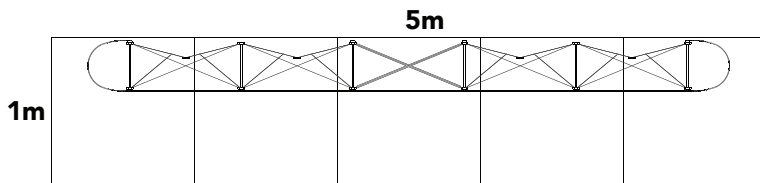

CODE | COMBI03

CONTENTS |

3 IN 1 KIT - P32/P32

- 2 x P32 Frame
- 8 x Magnetic Struts
- 2 x Plus to Plus Connecting Scissors
- 2 x 90 Degree Connecting Scissors
- 1 x Photo Mural Kit
- 1 x RollOne Case

 32KG

CODE | COMBI03G

CONTENTS |

3 IN 1 KIT - P32/P32 WITH GRAPHICS

- 2 x P32 Frame
- 8 x Magnetic Struts
- 2 x Plus to Plus Connecting Scissors
- 2 x 90 Degree Connecting Scissors
- 1 x RollOne Case
- 1 x Set of Graphics

 34KG

C04



2m

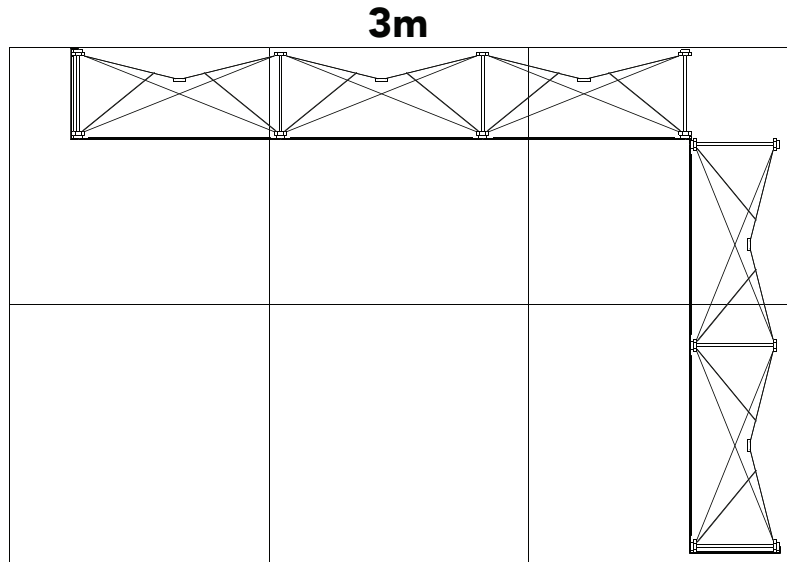

Assembled Dimensions
2.36m H x 2.73m W x 1.95m D

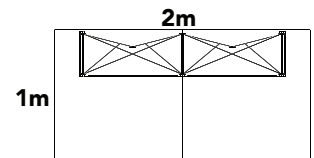
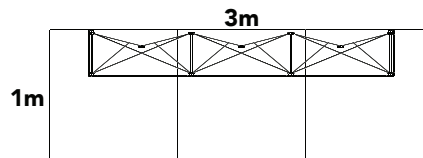
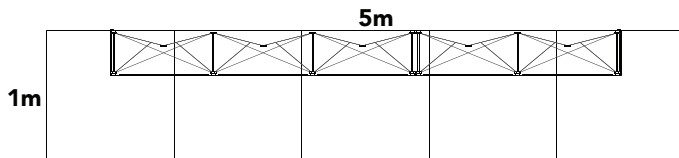

CODE | COMBI04

CONTENTS |

3 IN 1 KIT - P32/P33

- 1 x P32 Plus Frame
- 1 x P33 Plus Frame
- 7 x Magnetic Struts
- 1 x Three Quad High Hinged Strut
- 1 x Photo Mural Kit
- 1 x RollOne Case

 34KG

CODE | COMBI04G

CONTENTS |

3 IN 1 KIT - P32/P33 WITH GRAPHICS

- 1 x P32 Plus Frame
- 1 x P33 Plus Frame
- 7 x Magnetic Struts
- 1 x Three Quad High Hinged Strut
- 1 x RollOne Case
- 1 x Set of Graphics

 36KG

C05

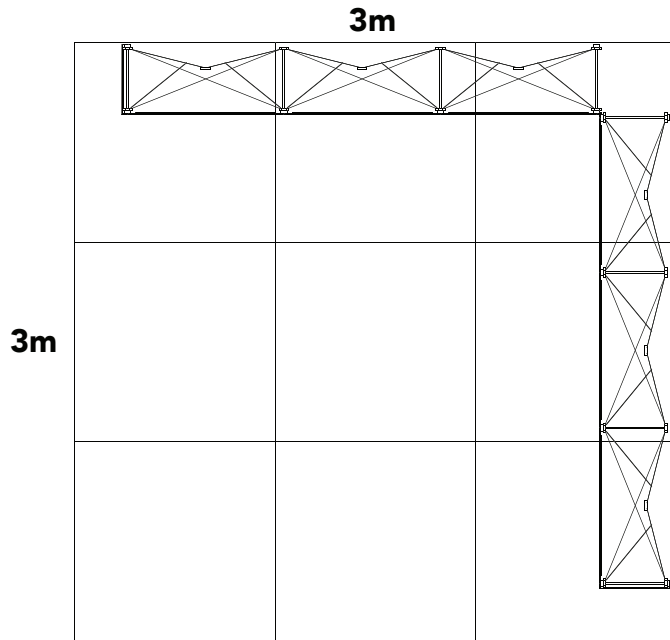
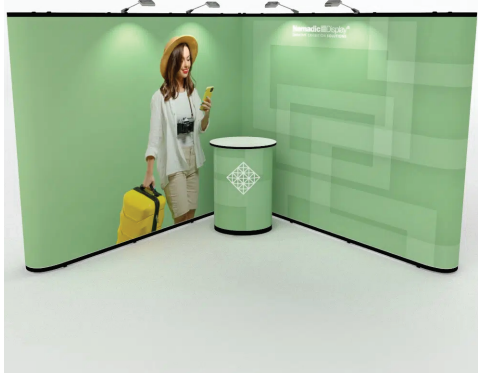

Assembled Dimensions
2.36m H x 2.73m W x 2.73m D

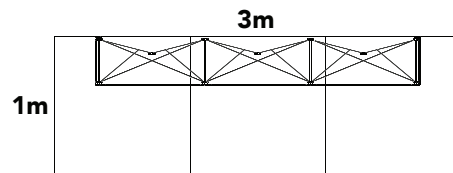
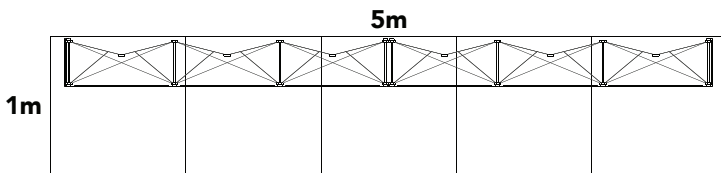

CODE | COMBI05

CONTENTS |

3 IN 1 KIT - P33/P33

- 2 x P33 Plus Frame
- 8 x Magnetic Struts
- 1 x Three Quad High Hinged Strut
- 1 x Photo Mural Kit
- 1 x RollOne Case
- 1 x RollPlus Case

 43KG

CODE | COMBI05G

CONTENTS |

3 IN 1 KIT - P33/P33 WITH GRAPHICS

- 2 x P33 Plus Frame
- 8 x Magnetic Struts
- 1 x Three Quad High Hinged Strut
- 1 x RollOne Case
- 1 x RollPlus Case

 45KG

SETTING UP YOUR DISPLAY



1 Place frame with red studs facing front.

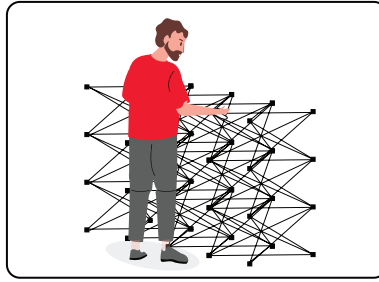

2 Grasp two top centre hubs and lift frame open to shoulder height. Handle frame at hubs only.

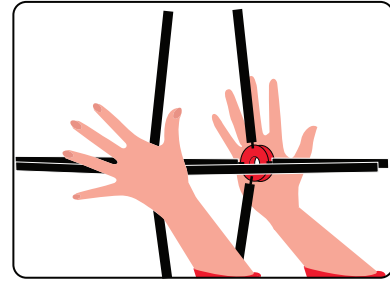

3 Press front and back hubs in the centre of the frame until Instand locks into position. (Front and back hubs do not meet.)

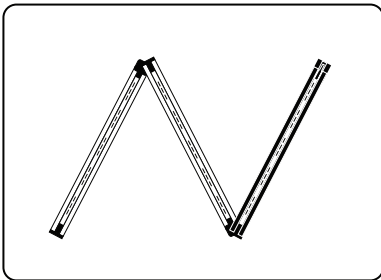

4 Unfold connected strut ensuring magnets are facing the same direction...

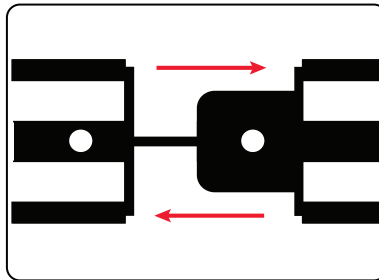

5 ...and connect bottom two sections by joining as illustrated.

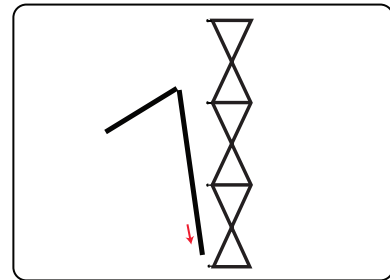

6 Slide bottom of connected strut onto the red stud at the bottom of the frame.

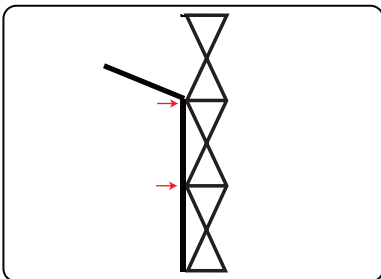

7 Snap next two connectors onto studs on frame.

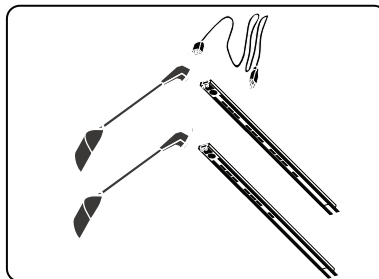

8 Attach lights to top of struts. Swivel fixtures to adjust position. Run cord behind display.

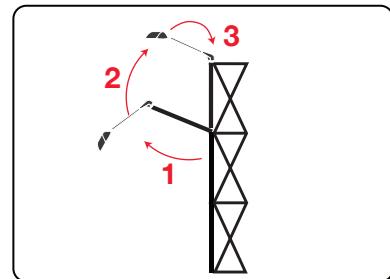

9 Rotate top section of strut up and slide down onto top stud.

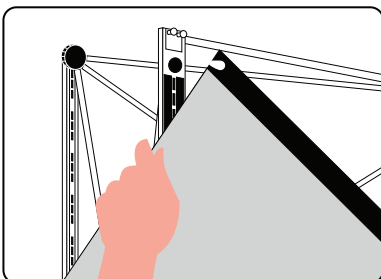

10 Hang all top panels and full size panels first. Lift onto studs on top of frame. Hook one side then the other. Gradually release downward to bond magnets.



11 Bow endcaps and lift onto studs on top of both sides of frame. For hinged panels hook one side then the other. Slide hands along length of panel to bond magnets.

UPGRADES



Single LED Light in a Tuxedo Box

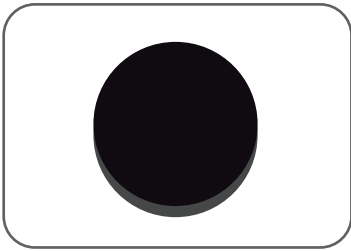

RollPlus Insert Top

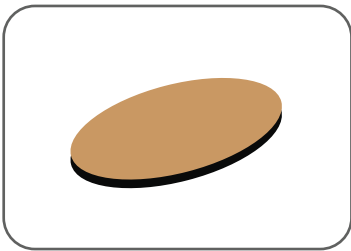

RollOne Premium Counter Top

FREE-STANDING ACCESSORIES

Evolve - Modular Counter Series



MODCTRRECONE

Rectangular Single Module in a Flex Case

MODCTRRECEXTRA1

Rectangular Extra Module in a Flex Case

MODTRCURONE

Curved Single Module in a Flex Case

MODTRCUREXTRA1

Curved Extra Module in a Flex Case

MODCTR90COR

90 Degree Corner Module in a Flex Case

REC Counter Range



REC900/1000

REC900

Graphic Counter with door in a Flex Case

RED1000

Graphic Counter without door in a Flex Case

CDL012 SCREEN KIOSKS

Screen Kiosk with tool-less assembly in a Flex Case



CDL013 SHELF KIOSKS

Shelf Kiosk with tool-less assembly in a Flex Case



*extra cases may be required for graphics/accessories.

NOTES

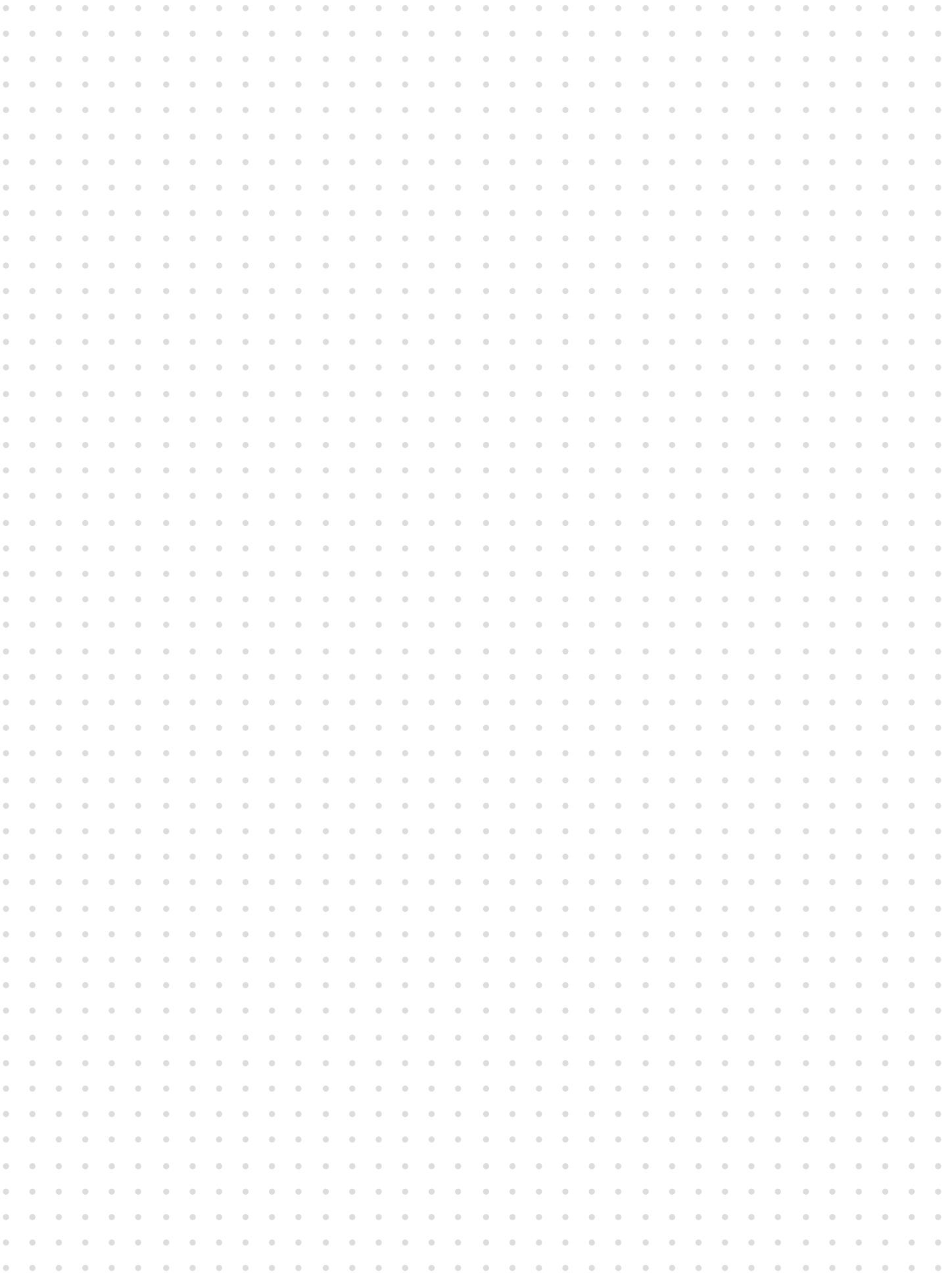



INSTAND[®] DESIGN

DESIGN 01

The Nomadic range of Designs allow you to invest in a stand today knowing that as your business and exhibition requirements grow, you can add new solutions to your purchase to scale that stand up and make it even larger in the future.

Accommodate new design features that may not even exist today but are key to your exhibition needs tomorrow. Choose Nomadic to choose wisely.



- 1 x Combi 04
- 1 x P32 Basic Kit in a RollPlus Case
- 1 x 3 Quad High Hinged Strut
- 2 x Set of 2 LED lights
- 1 x RollOne Countertop
- 1 x CDL014 Large Monitor Mount

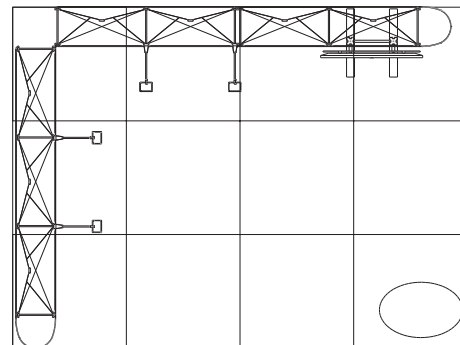

DESIGN 02



- 1 x Combi 04
- 1 x Combi 05
- 1 x P32 Basic Kit in a RollPlus Case
- 2 x 3 Quad High Hinged Strut
- 3 x Set of 2 LED lights
- 1 x Set of 3 LED lights
- 2 x Curved evolve counter
- 1 x CDL014 Large Monitor Mount
- 1 x 1 Quad High Delux Showcase
- 2 x Floating Product Display Shelves

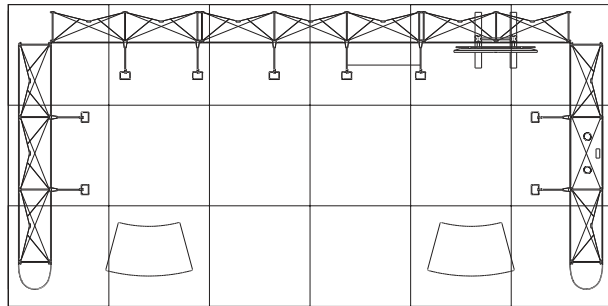

DESIGN 03



- 1 x Combi 04
- 1 x Combi 05
- 2 x P32 Basic Kit in a RollPlus Case
- 1 x P31 Basic Kit in a RollPlus Case
- 3 x 3 Quad High Hinged Strut
- 4 x Set of 2 LED lights
- 1 x Set of 3 LED lights
- 1 x Double Curved evolve counter
- 1 x CDL014 Large Monitor Mount
- 1 x 1 Quad High Delux Showcase
- 2 x Floating Product Display Shelves
- 3 x A4 Literature Holders

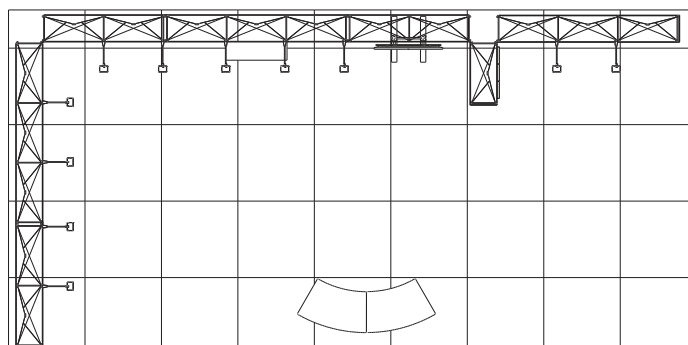

DESIGN 04



- 2 x C34 Basic Kit in a RollOne Case
- 2 x RollOne Premium Counter Top
- 2 x Set of 2 LED lights
- 1 x 3 Quad High Hinged Strut

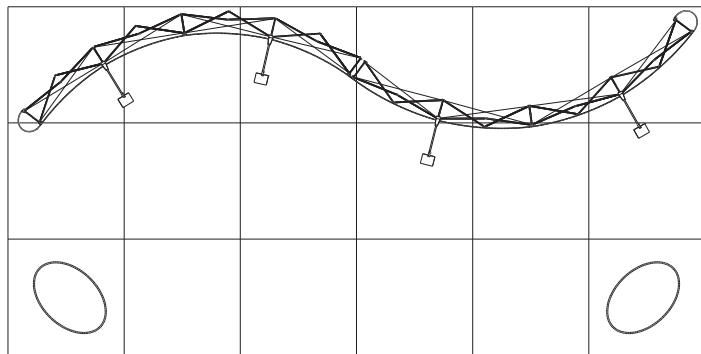

Reconfigurations



DESIGN 05



- 1 x C33 Basic Kit in a RollPlus Case
- 1 x Combi 04
- 1 x P12E Frame with Struts
- 1 x Double Flat evolve counter
- 1 x CDL014 Large Monitor Mount
- 2 x Set of 2 LED lights
- 1 x Curtain Pole

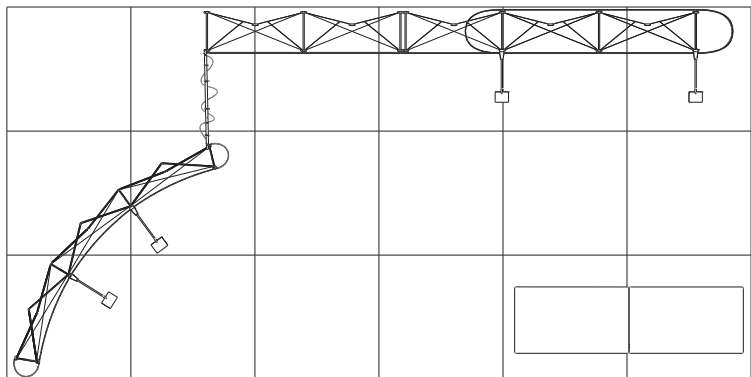

Reconfigurations



DESIGN 06



- 1 x C34 Basic Kit in a Rollone Case
- 1 x P31 Basic Kit in a Cylindrical Case
- 1 x Curtain Pole
- 1 x Set of 2 LED lights
- 1 x Folding Literature Holder
- 1 x REC900 counter

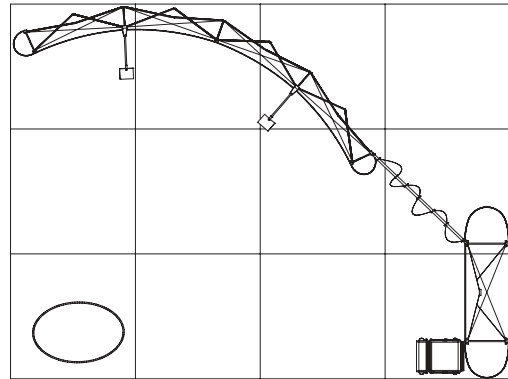

Reconfigurations



DESIGN 07



- 2 x C33 Basic Kit in a RollOne Case
- 2 x C32 Basic Kit in a RollPlus Case
- 2 x Curtain Pole
- 1 x Classic Monitor Mount - Convex
- 1 x Double curved evolve
- 3 x Set of 2 LED lights

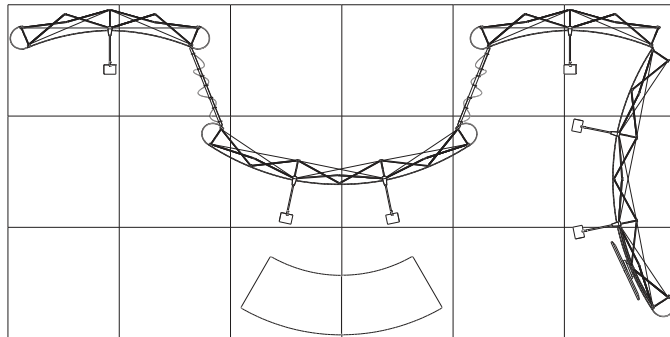

Reconfigurations



DESIGN 08



- 2 x P32 Basic Kit in a RollPlus 33 Case
- 2 x P42 Frames
- 6 x 4 Quad High Connected Strut
- 3 x 4 Quad High Hinged Strut
- 2 x Set of 2 LED lights
- 1 x 90 Degree evolve counter
- 1 x RollOne Case

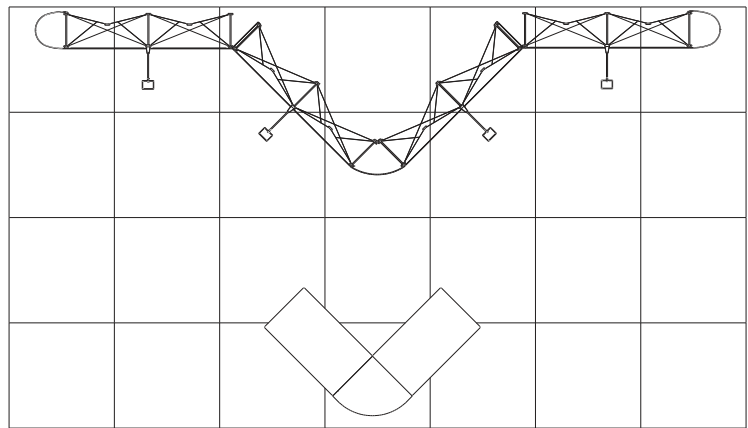

Reconfigurations



DESIGN 09



- 1 x Combi 04
- 1 x P33 Basic Kit in a RollPlus Case
- 1 x 3 Quad High Hinged Strut
- 1 x CDL014 Large Monitor Mount
- 2 x Set of 2 LED lights
- 4 x A4 Lit. Holders
- 2 x Floating Product Display Shelves
- 1 x Rectangle evolve counter

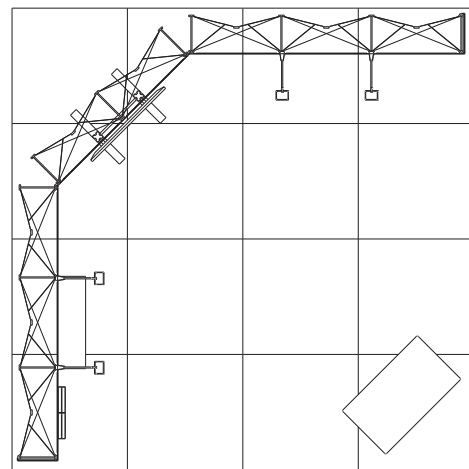

Reconfigurations



BRIGHTWALL INTEGRATION

Combine the impact that comes from the illuminated BrightWall 2 units with the unparalleled functionality of the full Nomadic Instand range with one easy to use connector. Existing Instand stands can be upgraded with BrightWall 2 units starting at 1mtr wide and ranging up to 3mtr wide. Developed with ease, portability and modularity in mind, the Instand to BrightWall 2 connection solution makes the traditional solution modern.



- 1 x C33 Basic Kit in a RollOne Case
- 2 x P32 Basic Kit in a Cylindrical Case
- 1 x P31 Basic Kit in a Cylindrical Case
- 2 x Curtain Pole
- 3 x A4 Literature Holder
- 1 x CDL014 Large Monitor Mount
- 1 x 3m BrightWall 2
- 1 x BrightCounter
- 1 x Set of 2 LED lights

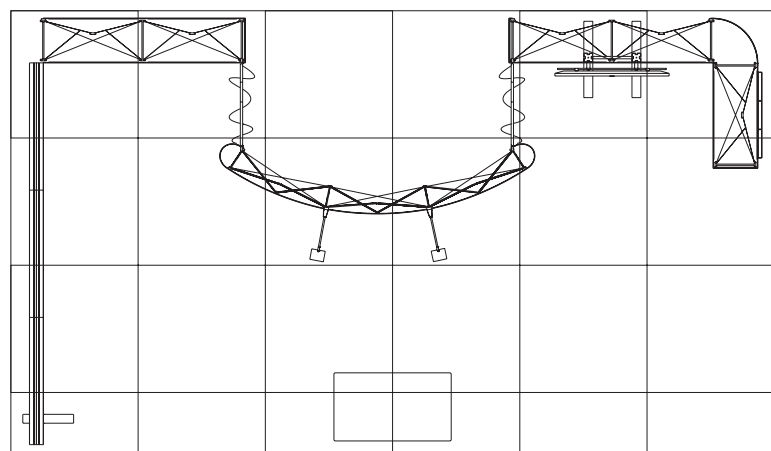

BRIGHTWALL INTEGRATION



- 1 x C33 Basic Kit in a RollOne Case
- 1 x 1.32m BrightWall 2 in a FlexCase
- 1 x Single Curved Evolve Counter
- 1 x Set of 2 LED lights
- 1 x Instand-BrightWall Connector

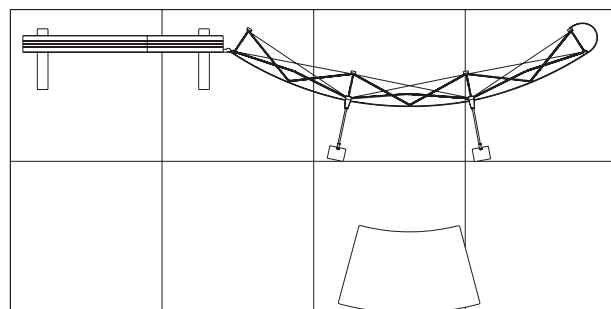

NOTES

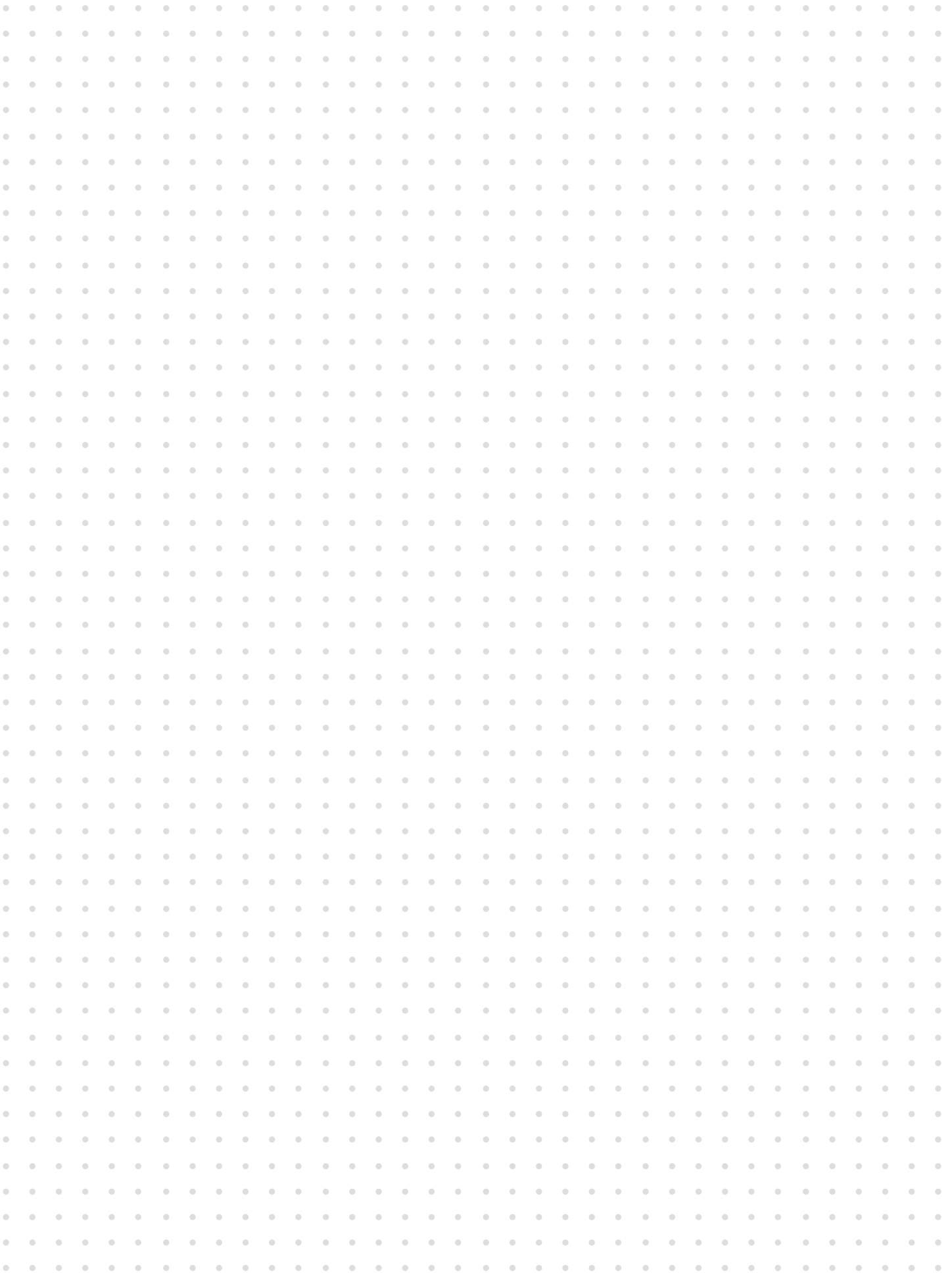

NOTES

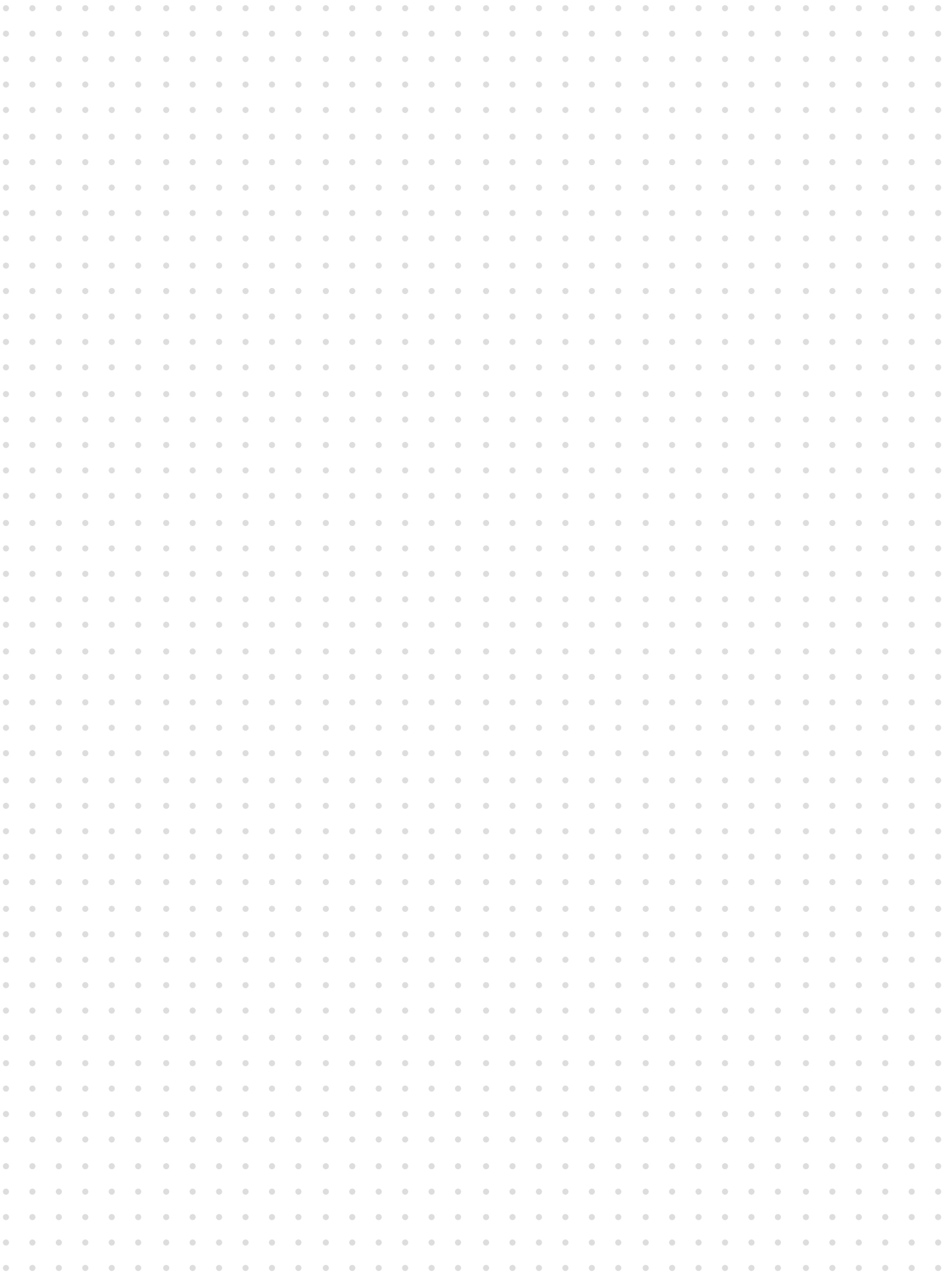



JEROME GANNON

Managing Director

With over 40 years of industry expertise, Nomadic Display stands as a beacon of unmatched craftsmanship, proudly made in Europe. Our legacy is built on delivering exceptional quality and innovative designs that stand the test of time, ensuring your brand makes a memorable impact on the global stage



Caher, Louisburgh,
Co. Mayo, F28P660



+353 98 66011



sales@nomadicdisplay.eu